

AMC100 DC precision power distribution monitoring device

Installation instruction V1.1

Declaration

All rights reserved. Without the written permission of the company, any paragraph or chapter in this manual shall not be copied, copied or transmitted in any form. Otherwise, all consequences shall be borne by the violator.

All legal rights are reserved.

The company reserves the right to modify the product specifications described in this manual without prior notice. Please contact your local agent for new specifications before ordering.

Contents

1	General.....	1
2	Product Model.....	1
3	Technical parameters.....	1
4	Appearance structure.....	5
5	Wiring Terminals.....	6
5.1	AMC100-ZD.....	6
5.2	AMC100-FD30/FD48.....	8
5.3	AMC100-FDK30/FDK48.....	10
5.4	AMC100-KA30/KA48.....	12
5.5	AMC100-KD30/KD48.....	13
5.6	AMC100-FT30/FT48.....	14
6	Communication agreement.....	16
6.1	Sketch of the Protocol	16
6.2	Transmission mode.....	16
6.3	Function Code Introduction.....	17
6.4	Correspondence address.....	18
7	Matters needing attention.....	44
8	Common Fault Diagnosis and Troubleshooting.....	44

1 General

With the rapid development of data centers, the energy consumption of data centers has become more and more prominent, and the energy management and power supply and distribution design of data centers have become a hot issue. Efficient and reliable power distribution system scheme of data centers is an effective way to improve the power efficiency of data centers and reduce the energy consumption of equipment. In order to realize energy saving in data center, first of all, it is necessary to monitor each power load. However, there are many load loops in data center, and traditional measuring instruments cannot meet the requirements of cost, volume, installation, construction and other aspects. Therefore, it is necessary to adopt multi-loop monitoring device suitable for centralized monitoring requirements in data center.

AMC100 series DC precision power distribution monitor is a measurement device designed specifically for power management of data center servers. The device design exquisite, can for A + B two into line and 192 road for electrical parameters, the input and output parameters of the switch state and the lightning protection device such as real-time monitoring, all alarm threshold measurement channels can be set in A separate, to qualify the limit event trigger system sound and light alarm, immediately on the volume in the traditional instrument, the height of the monitoring circuit integration.

2 Product Model

Model	Functional Description
AMC100-ZD	Monitors the voltage, current, power, and electric energy of 2 independent incoming lines A+B, 8 switching input, 4 switching output, 1 temperature and humidity detection, and 3 RS485 communications
AMC100-FDK30	Monitor the full power parameters and switching status (active) of A+B dual DC outlet 30 branches, and 1 RS485 communication
AMC100-FDK48	Monitor the full power parameters and switching status (active) of A+B dual DC outlet 48 branches, and 1 RS485 communication
AMC100-FD30	Monitor the full power parameters of A+B dual DC outgoing lines in A total of 30 branches, and 1 RS485 communication
AMC100-FD48	Monitor the full power parameters of A+B dual DC outgoing lines in A total of 48 branches, and 1 RS485 communication
AMC100-KA30	Wet contact, Monitor the switching status of 30 branches A+B, and 1 RS485 communication
AMC100-KA48	Wet contact, Monitor the switching status of 48 branches A+B, and 1 RS485 communication
AMC100-KD30	Dry contact: Monitor the switching status of 30 branches A+B, and 1 RS485 communication
AMC100-KD48	Dry contact: Monitor the switching status of 48 branches A+B, and 1 RS485 communication
AMC100-FT30	1 channel RS485 communication and 30 channels temperature measurement
AMC100-FT48	1 channel RS485 communication and 48 channels temperature measurement

3 Technical parameters

DC into line

Instrument model		AMC100-ZD
Measured parameters		Voltage, Current, Power, Electric energy, Ambient temperature and Humidity
Bus voltage	Rated	48VDC, 240VDC, 336VDC
	Measuring range	±20%
	Overload	Instantaneous voltage 2 times per second
Current incoming circuit	Rated	5V (Hall sensor, ±12V powered by AMC100-ZD)
	Overload	Duration is 1.2 times, instantaneous 10 times/second
Temperature and humidity	Temperature range	-40°C ~ +99°C
	Humidity range	20% ~ 90%
Measuring accuracy	Coil in	Voltage/current level 0.5, power/electric energy level 1
	Temperature	±1°C
	Humidity	±5%

Auxiliary supply		<p>AMC100-ZD: Signal power ($\leq 15W$)</p> <p>AMC100-ZD-P24: DC 12-24V independent power supply</p> <p>AMC100-ZD-P220:</p> <p>1、 When the constant voltage is DC 240V、 DC336V, powered by AC220V、 DC240V 、 DC336V independent supply</p> <p>2、 When the constant voltage is DC 48V, powered by DC48V independent supply</p>
Environment	Temperature	Operation: $-15^{\circ}C \sim 55^{\circ}C$ Storage: $-25^{\circ}C \sim 70^{\circ}C$
	Humidity	Relative humidity $\leq 93\%$
	Altitude	$\leq 2500m$
Switching output		4-way 3A 250VAC /3A 30VDC
Switch input		8 dry nodes
Communication		<p>1 channel isolated RS485/Modbus-RTU to the background system</p> <p>1 RS485/Modbus-RTU to touch screen</p> <p>1 RS485/Modbus-RTU connection to the downstream module</p> <p>1-channel Ethernet communication function is optional</p>
Installation		Method DIN35mm rail or bottom plate installation
Protection level		IP20
Pollution level		2
Security	Insulation	The insulation resistance between all terminals and the conductive parts on the shell must be at least $100M\Omega$
	Withstand voltage	Voltage and current signal of line A // Voltage and current signal of line B // Switching output // Isolated communication port // Two of other ports should meet AC2kV for 1min, switching input and other ports should meet AC0.5kV for 1min, leakage current should be less than 2mA, no breakdown or flashover phenomenon.
Electromagnetic compatibility	Antistatic interference	Level 4
	Reactance fast transient pulse	Level 3
	Surge resistance	Level 4
	Radio frequency electromagnetic radiation	Level 3

DC outlet

Instrument model		AMC100-FD30	AMC100-FD48
Measuring parameters		Voltage, Current, Power, Electric energy	
Bus voltage	Rated	48VDC, 240VDC, 336VDC	
	Measuring range	$\pm 20\%$	
	Overload	Instantaneous voltage 2 times per second	
Current incoming circuit	Rated	5V (Hall sensor, need external power supply $\pm 12V$ or $\pm 15V$)	
	Range		
	Overload	Duration is 1.2 times, instantaneous 10 times/second	
Measuring accuracy	coil out	Voltage/current level 0.5, power/electric energy level 1	
Auxiliary supply		Powered by AMC100-ZD; DC 12-24V power supply when used alone	
Environment	Temperature	Operation: $-15^{\circ}C \sim 55^{\circ}C$ Storage: $-25^{\circ}C \sim 70^{\circ}C$	
	Humidity	Relative humidity $\leq 93\%$	
	Altitude	$\leq 2500m$	
Communication		RS485/Modbus-RTU	

Installation		Method DIN35mm rail or bottom plate installation
Protection level		IP20
Pollution level		2
Security	Insulation	The insulation resistance between all terminals and the conductive parts on the shell must be at least 100MΩ
	Withstand voltage	Voltage and current signal of line A // Voltage and current signal of line B // The two of other ports meet AC2kV for 1min, the leakage current should be less than 2mA, and no breakdown or flashover phenomenon.
Electromagnetic compatibility	Antistatic interference	Level 4
	Radio frequency electromagnetic radiation	Level 3

Note: The input voltage of the secondary side of the DC inlet and outlet modules is 5V, and the default value of the primary side current is 100A. If the hall sensor is different, customers can set the ratio through the touch screen according to the actual use.

Instrument model		AMC100-FDK30	AMC100-FDK48
Measuring parameters		Voltage, Current, Power, Electric energy	
Bus voltage	Rated	48VDC,240VDC,336VDC	
	Measuring range	±20%	
	Overload	Instantaneous voltage 2 times per second	
Current incoming circuit	Rated	5V (Hall sensor, need external power supply ±12V or ±15V)	
	Range		
	Overload	Duration is 1.2 times, instantaneous 10 times/second	
Measuring accuracy	coil out	Voltage/current level 0.5, power/electric energy level 1	
Auxiliary supply		Powered by AMC100-ZD; DC 12-24V power supply when used alone	
Environment	Temperature	Operation: -15°C~55°C Storage: -25°C~70°C	
	Humidity	Relative humidity≤93%	
	Altitude	≤2500m	
Communication		RS485/Modbus-RTU	
Installation		Method DIN35mm rail or bottom plate installation	
Protection level		IP20	
Pollution level		2	
Security	Insulation	The insulation resistance between all terminals and the conductive parts on the shell must be at least 100MΩ	
	Withstand voltage	Voltage and current signal of line A // Voltage and current signal of line B // The two of other ports meet AC2kV for 1min, the leakage current should be less than 2mA, and no breakdown or flashover phenomenon.	
Electromagnetic compatibility	Antistatic interference	Level 4	
	Radio frequency electromagnetic radiation	Level 3	

Note: The input voltage of the secondary side of AMC100-FDK module is 5V, and the default value of the primary side current is 100A. If the hall sensor is different, customers can set the ratio through the touch screen according to the actual use.

Active switch module

Instrument model		AMC100-KA30	AMC100-KA48
Auxiliary supply		Powered by AMC100-ZD; DC 12-24V power supply power supply when used alone	
Environment	Temperature	Operation: -15°C~55°C	Storage: -25°C~70°C
	Humidity	Relative humidity≤93%	
	Altitude	≤2500m	
Switch input		30 wet nodes (48VDC,240VDC,336VDC)	48 wet nodes (48VDC,240VDC,336VDC)
Communication		RS485/Modbus-RTU	
Installation		Method DIN35mm rail or bottom plate installation	
Protection level		IP20	
Pollution level		2	
Security	Insulation	The insulation resistance between all terminals and the conductive parts on the shell must be at least 100MΩ	
	Withstand voltage	Voltage and current signal of line A // Voltage and current signal of line B // The two of other ports meet AC2kV for 1min, the leakage current should be less than 2mA, and no breakdown or flashover phenomenon.	
Electromagnetic compatibility	Antistatic interference	Level 4	
	Radio frequency electromagnetic radiation	Level 3	

Passive switching module

Instrument model		AMC100-KD30	AMC100-KD48
Auxiliary supply		Powered by AMC100-ZD; DC 12-24V power supply when used alone	
Environment	Temperature	Operation: -15°C~55°C	Storage: -25°C~70°C
	Humidity	Relative humidity≤93%	
	Altitude	≤2500m	
Switch input		30 dry nodes	48 dry nodes
Communication		RS485/Modbus-RTU	
Installation		Method DIN35mm rail or bottom plate installation	
Protection level		IP20	
Pollution level		2	
Security	Insulation	The insulation resistance between all terminals and the conductive parts on the shell must be at least 100MΩ	
	Withstand voltage	Voltage and current signal of line A // Voltage and current signal of line B // The two of other ports meet AC2kV for 1min, the leakage current should be less than 2mA, and no breakdown or flashover phenomenon.	
Electromagnetic compatibility	Antistatic interference	Level 4	
	Radio frequency electromagnetic radiation	Level 3	

Temperature measurement module

Instrument model		AMC100-FT30	AMC100-FT48
Number of measuring channels		30 channels	48 channels
Auxiliary supply		Powered by AMC100-ZD; DC 12-24V power supply when used alone	

Function	Temperature measurement range	-20°C~150°C
	Communication	RS485/Modbus-RTU
Installation		Method DIN35mm rail or bottom plate installation
Protection level		IP20
Pollution level		2
Environment	Temperature	Operation: -20°C~60°C Storage: -25°C~70°C
	Humidity	Relative humidity≤93%
	Altitude	≤2500m
Security	Insulation	The insulation resistance between all terminals and the conductive parts on the shell must be at least 100MΩ
	Withstand voltage	The auxiliary power supply and temperature measurement meet AC2kV for 1min, the leakage current should be less than 2mA, and no breakdown or flashover phenomenon.
Electromagnetic compatibility	Antistatic interference	Level 4
	Radio frequency electromagnetic radiation	Level 3

4 Appearance structure

AMC100 series DC precision power distribution monitoring device

Unit:mm

AMC100-ZD、AMC100-FD□48、AMC100-K□48、AMC100-FT48

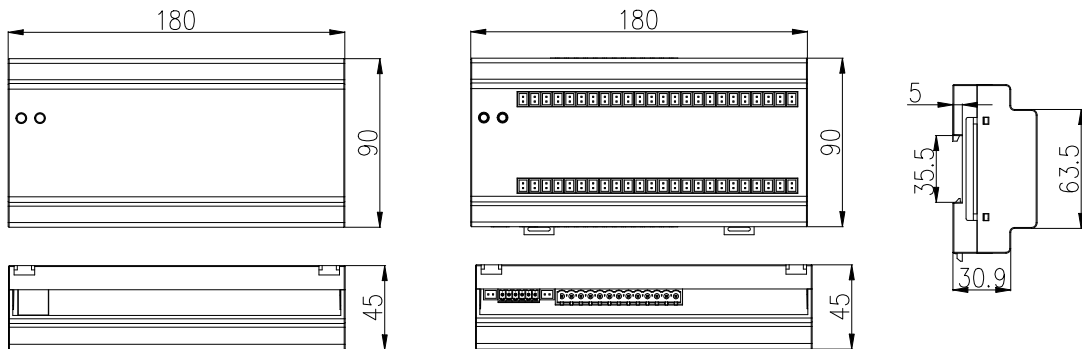

AMC100-FD□30、AMC100-K□30、AMC100-FT30

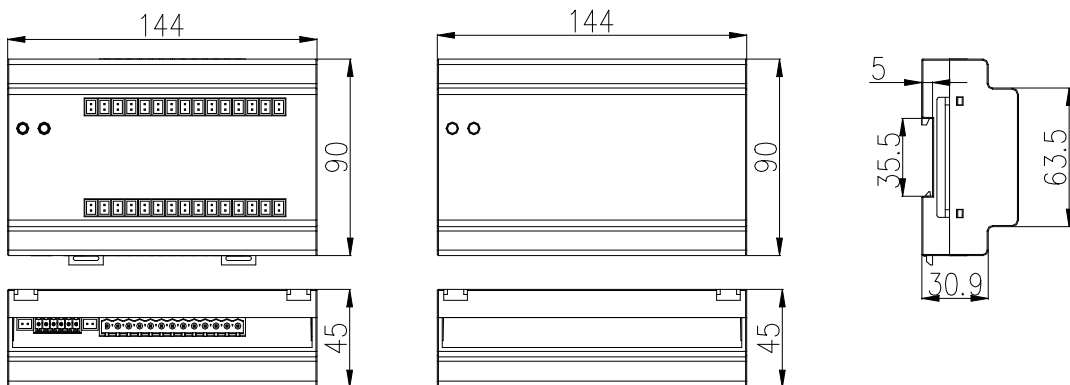

5 Wiring Terminals

5.1 AMC100 -ZD series

AMC100-ZD/CE-P220

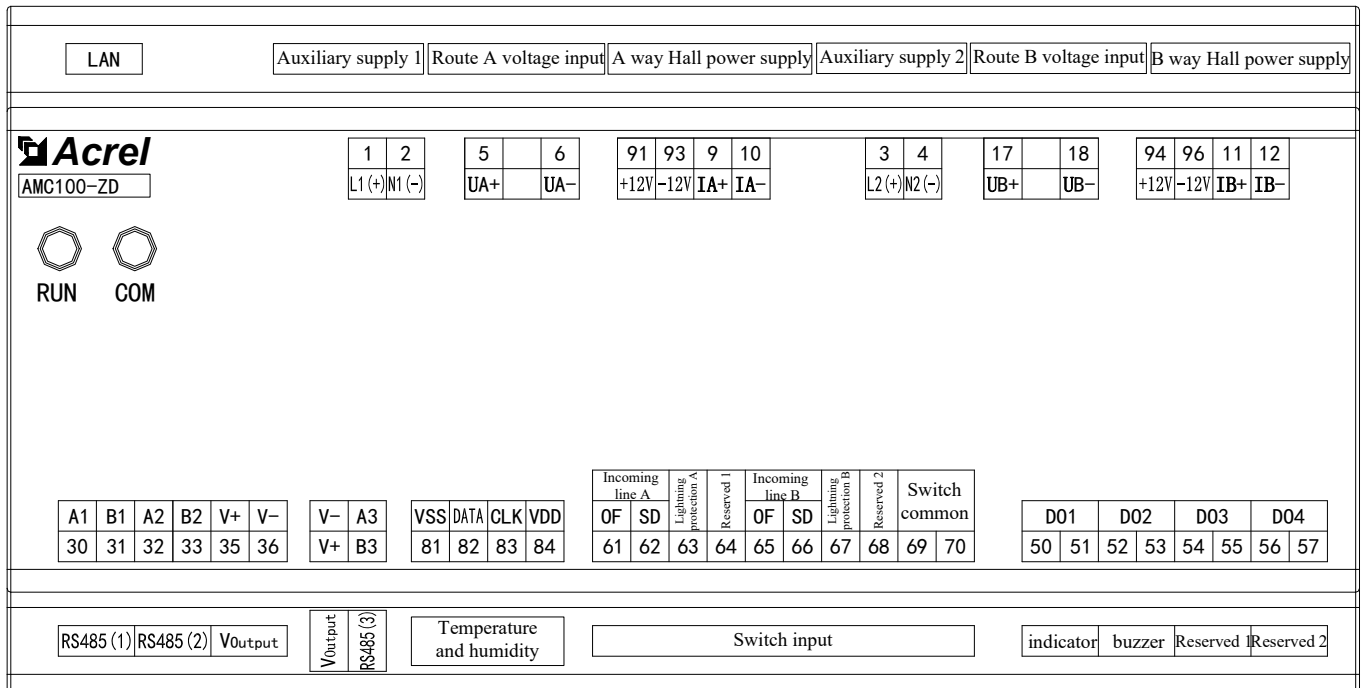

AMC100-ZD/CE-P24

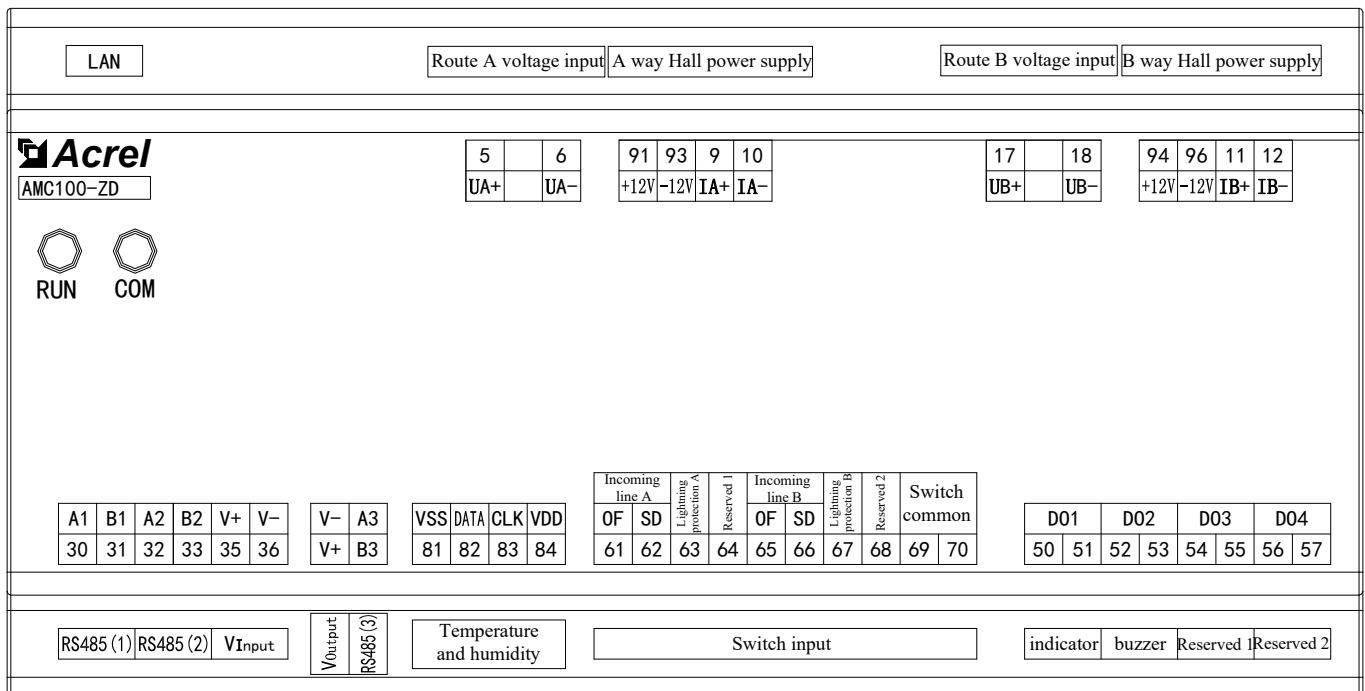

Terminal number	Definition	Description	Remark
1	L1(+)	Auxiliary supply 1	P220 used, not connected by default
2	N1(-)		
3	L2(+)	Auxiliary supply 2	P220 used, not connected by default
4	N2(-)		
5	UA+	Route A voltage input	Line A DC voltage input
6	UA-		
9	IA+	Route A current input	Line A incoming DC current

10	IA-		(Hall sensor input)
11	IB+	Route B current input	Line B incoming DC current (Hall sensor input)
12	IB-		
17	UB+	Route B voltage input	Line B incoming DC voltage input
18	UB-		
30	A1	RS485(1)	The first isolated communication interface, connected to the background system
31	B1		
32	A2	RS485(2)	The second channel is connected to the touch screen or RS485 hub
33	B2		
	A3	RS485(3)	The third way is connected to the downstream module
	B3		
	LAN	Ethernet	CE with Ethernet communication
35	V+	Power Output (auxiliary power input when use p24)	Power supply to AMC100-FD30/48, AMC100-FDK30/48, AMC100-KA30/48, AMC100-KD30/48, AMC100-FT30/FT48 and touch screen, this power supply prohibits external external equipment (such as indicator light, buzzer)
36	V-		
50	DO1	Switch output	Connect the buzzer
51			
52	DO2		Connection indicator
53			
54	DO3		Reserved 1
55			
56	DO4		Reserved 2
57			
61	Incoming line A	Switch input	OF
62			SD
63	Lightning protection A		Determine the SPD status of route A
64	Reserved		Reserved1
65	Incoming line B		OF+SD
66			SD
67	Lightning protection B		Determine the SPD status of route B
68	Reserved		Reserved2
69	Common port		Switch common
70			
81	VSS	Temperature and humidity	Connect WH-3 temperature and humidity sensor
82	DATA		
83	CLK		
84	VDD		
91	+12V	A way Hall power supply	Power Output
93	-12V		
94	+12V	B way Hall power supply	
96	-12V		

5.2 AMC100-FD30/FD48

AMC100-FD30

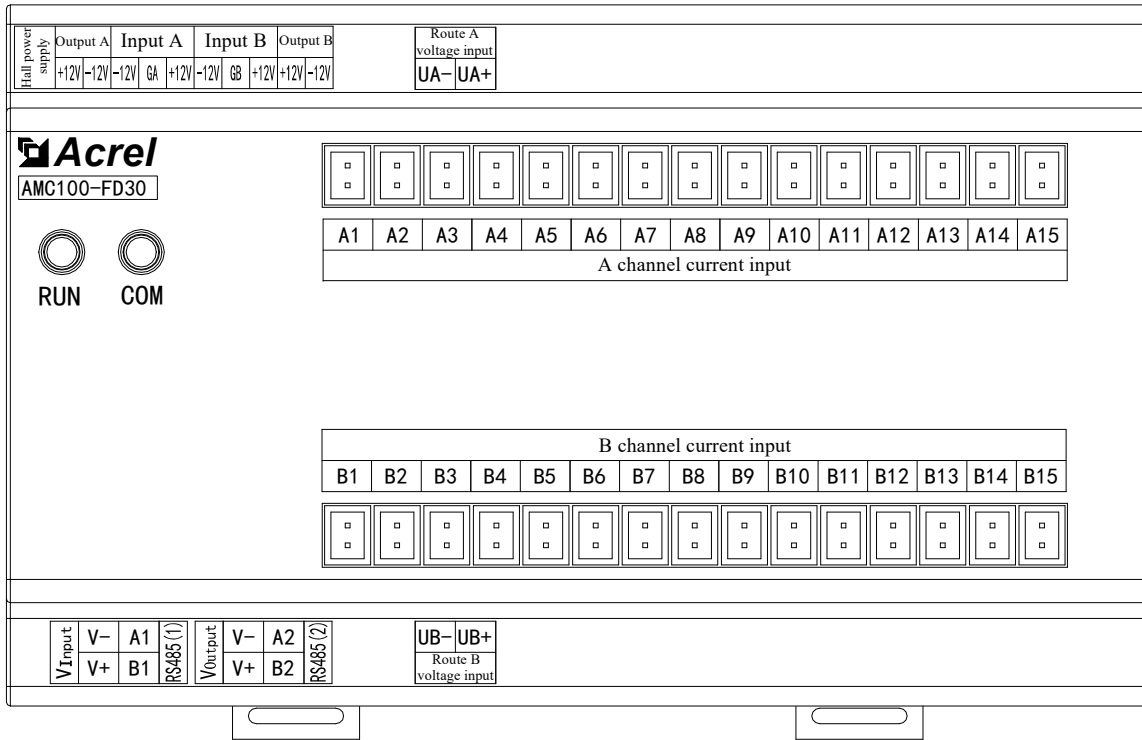

Definition	State	Remark
V+	Auxiliary supply	Powered by AMC100-ZD Or powered by DC12-24V power supply
V-		
A1	RS485 Communication (1)	Connect the pre-module
B1		
A2	RS485 Communication (2)	Connect the subsequent sub-module
B2		
UA+	Route A voltage input	Line A DC voltage input
UA-		
UB+	Route B voltage input	Line B DC voltage input
UB-		
Input A	A way Hall power supply input	±12V or ±15V switching power supply input
Output A	A way Hall power supply output	±12V or ±15V power output connected to Hall sensor
Input B	B way Hall power supply input	±12V or ±15V switching power supply input
Output B	B way Hall power supply output	±12V or ±15V power output connected to Hall sensor
A1-A15	A channel current input (15 channels)	A way outgoing DC current input (15 channels Hall sensor)
B1-B15	B channel current input (15 channels)	B way outgoing DC current input (15 channels Hall sensor)

AMC100-FD48

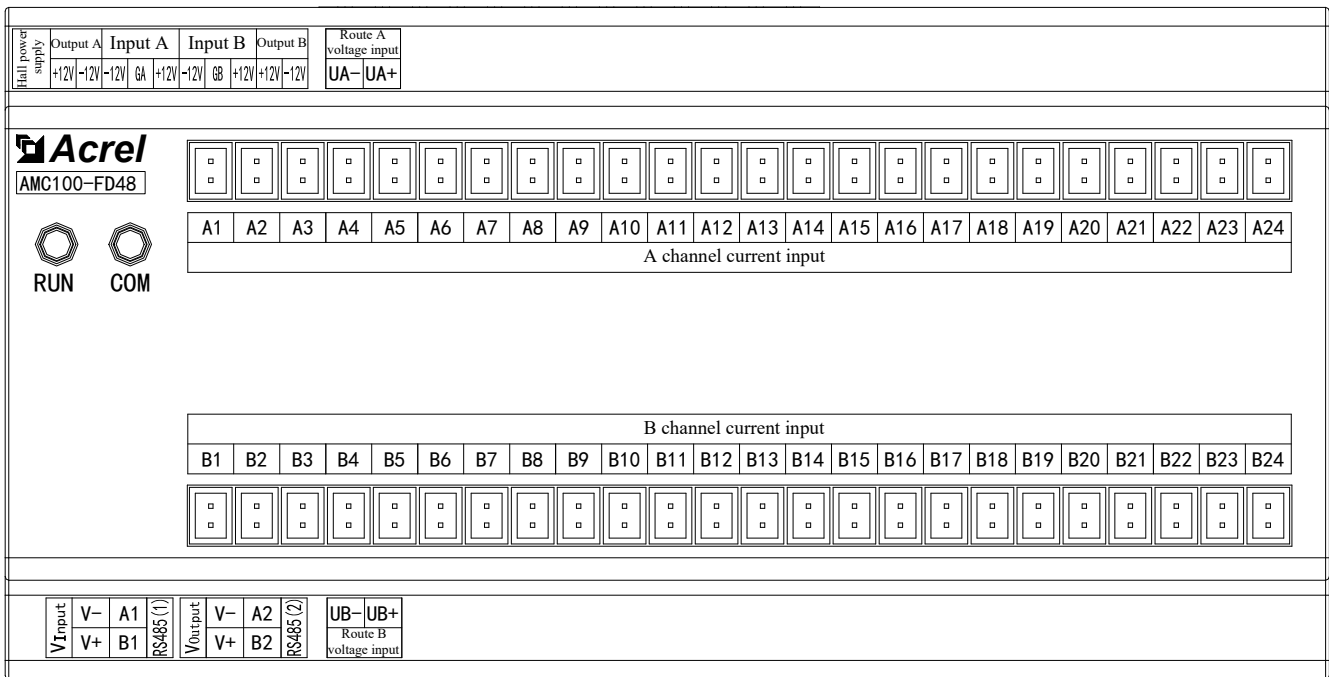

Definition	State	Remark
V+	Auxiliary supply	Powered by AMC100-ZD Or powered by DC12-24V power supply
V-		
A1	RS485 (1)	Connect the pre-module
B1		
A2	RS485 (2)	Connect the subsequent sub-module
B2		
UA+	Route A voltage input	Line A DC voltage input
UA-		
UB+	Route B voltage input	Line B DC voltage input
UB-		
Input A	A way Hall power supply input	±12V or ±15V switching power supply input
Output A	A way Hall power supply output	±12V or ±15V power output connected to Hall sensor
Input B	B way Hall power supply input	±12V or ±15V switching power supply input
Output B	B way Hall power supply output	±12V or ±15V power output connected to Hall sensor
A1-A24	A channel current input (24 channels)	A way outgoing DC current input (24 channels Hall sensor)
B1-B24	B channel current input (24 channels)	B way outgoing DC current input (24 channels Hall sensor)

5.3 AMC100-FDK30/FDK48

AMC100-FDK30

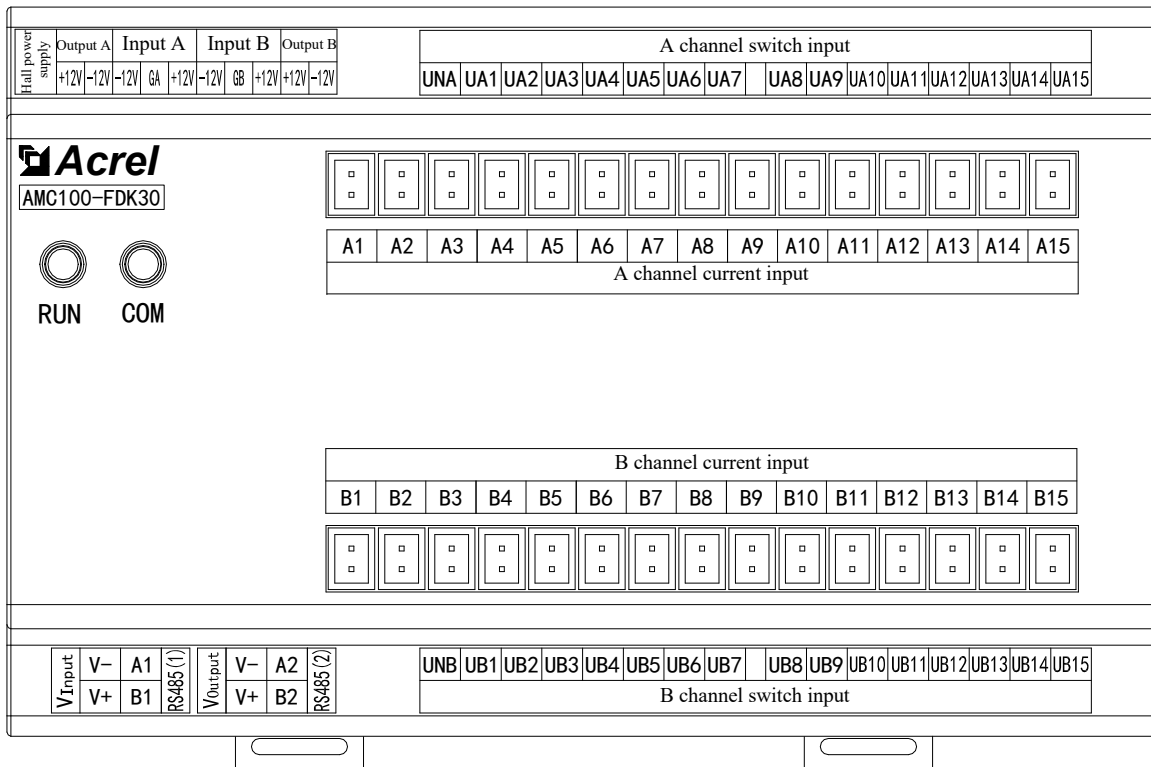

Definition	State	Remark
V+	Auxiliary supply	Powered by AMC100-ZD Or powered by DC12-24V power supply
V-		
A1	RS485 (1)	Connect the pre-module
B1		
A2	RS485 (2)	Connect the subsequent sub-module
B2		
UA+	Route A voltage input	Line A DC voltage input
UA-		
UB+	Route B voltage input	Line B DC voltage input
UB-		
Input A	A way Hall power supply input	$\pm 12V$ or $\pm 15V$ switching power supply input
Output A	A way Hall power supply output	$\pm 12V$ or $\pm 15V$ power output connected to Hall sensor
Input B	B way Hall power supply input	$\pm 12V$ or $\pm 15V$ switching power supply input
Output B	B way Hall power supply output	$\pm 12V$ or $\pm 15V$ power output connected to Hall sensor
A1-A15	A channel current input (24 channels)	A way outgoing DC current input (15 channels Hall sensor)
B1-B15	B channel current input (24 channels)	B way outgoing DC current input (15 channels Hall sensor)
UA1-UA15	A channel voltage input	A channel switch input (15 channels)
UNA		
UB1-UB15	B channel voltage input	B channel switch input (15 channels)
UNB		

AMC100-FDK48

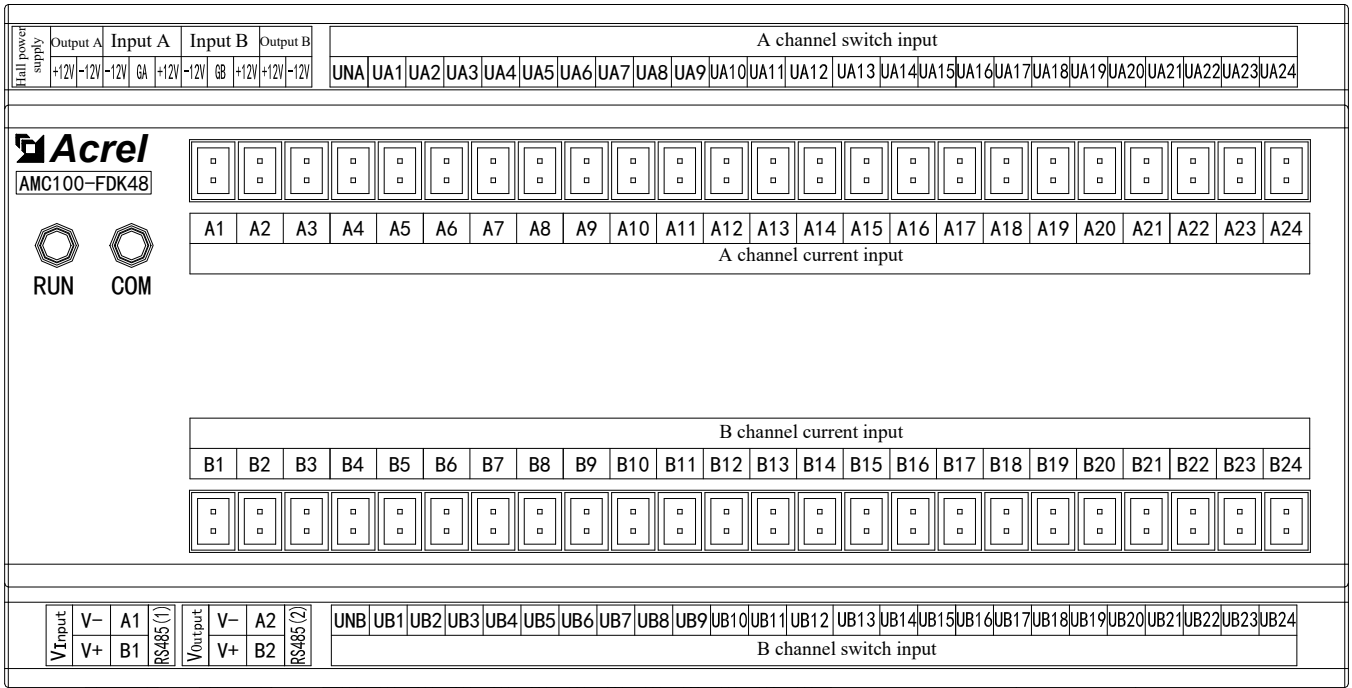

Definition	State	Remark
V+	Auxiliary supply	Powered by AMC100-ZD Or powered by DC12-24V power supply
V-		
A1	RS485 (1)	Connect the pre-module
B1		
A2	RS485 (2)	Connect the subsequent sub-module
B2		
UA+	Route A voltage input	Line A DC voltage input
UA-		
UB+	Route B voltage input	Line B DC voltage input
UB-		
Input A	A way Hall power supply input	±12V or ±15V switching power supply input
Output A	A way Hall power supply output	±12V or ±15V power output connected to Hall sensor
Input B	B way Hall power supply input	±12V or ±15V switching power supply input
Output B	B way Hall power supply output	±12V or ±15V power output connected to Hall sensor
A1-A24	A channel current input	A way outgoing DC current input (24 channels)
B1-B24	B channel current input	B way outgoing DC current input (24 channels)
UA1-UA24 UNA	A channel voltage input	A channel switch input (24 channels)
UB1-UB24 UNB		
	B channel voltage input	B channel switch input (24 channels)

5.4 AMC100-KA30/KA48

AMC100-KA30

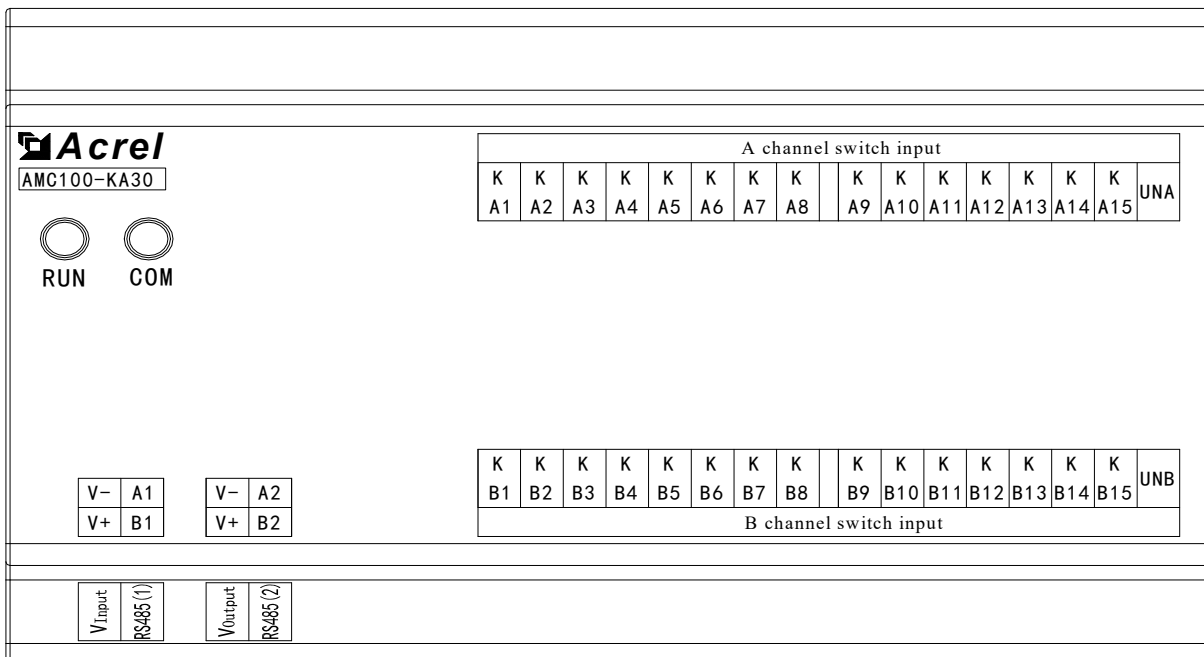

Definition	State	Remark
V+	Auxiliary supply	Powered by AMC100-ZD Or powered by DC12-24V power supply
V-		
A1	RS485(1)	Connect the pre-module
B1		
A2	RS485(2)	Connect the subsequent sub-module
B2		
KA1-KA15	A channel switch input	A channel active switch input (15 channels)
UNA		
KB1-KB15	B channel switch input	B channel active switch input (15 channels)
UNB		

AMC100-KA48

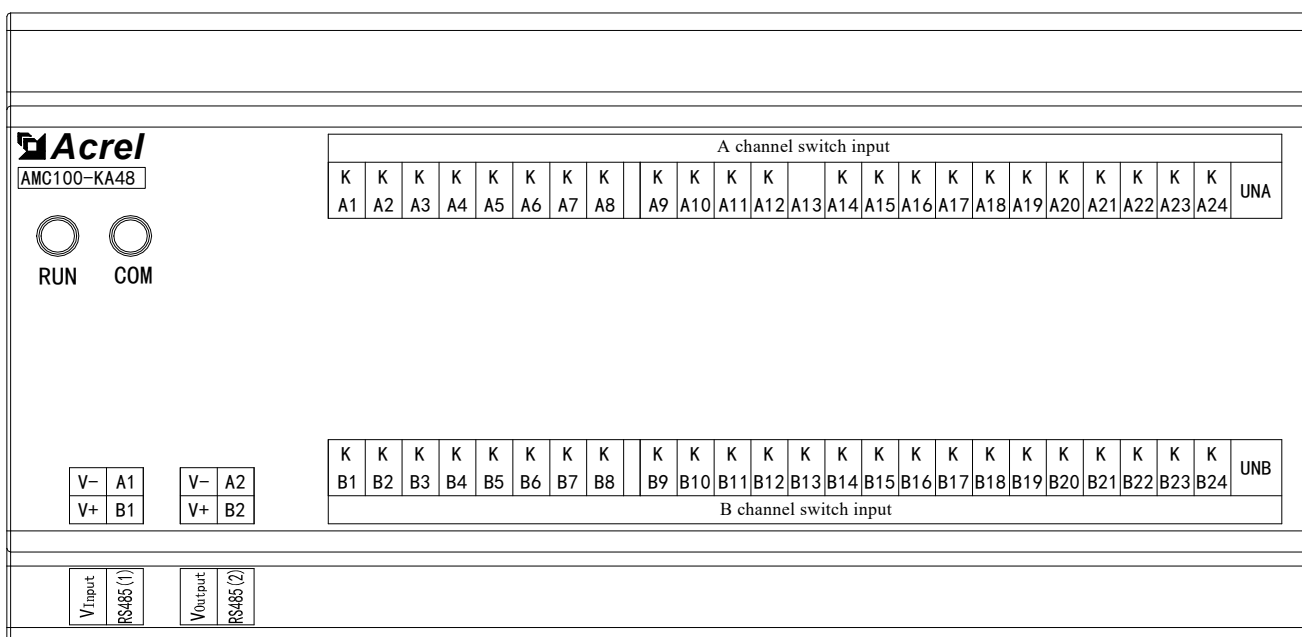

Definition	State	Remark
V+	Auxiliary supply	Powered by AMC100-ZD Or powered by DC12-24V power supply
V-		
A1	RS485(1)	Connect the pre-module
B1		
A2	RS485(2)	Connect the subsequent sub-module
B2		
KA1-KA24	A channel switch input	A channel active switch input (24 channels)
UNA		
KB1-KB24	B channel switch input	B channel active switch input (24 channels)
UNB		

5.5 AMC100-KD30/KD48

AMC100-KD30

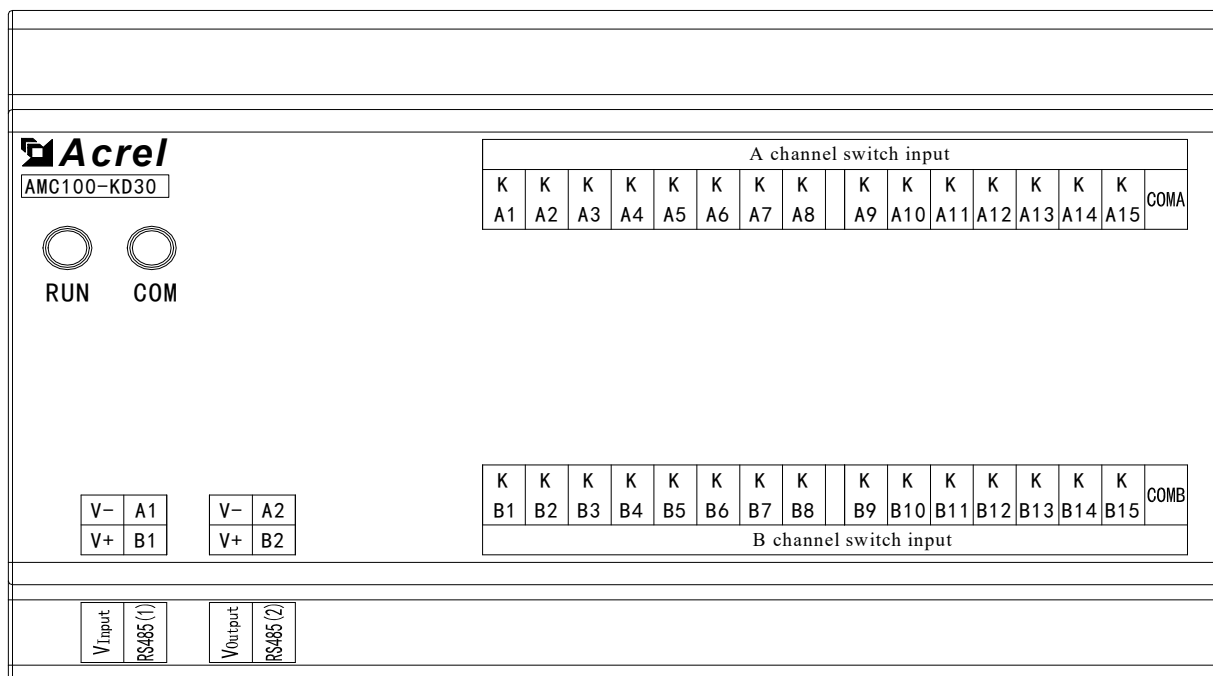

Definition	State	Remark
V+	Auxiliary supply	Powered by AMC100-ZD Or powered by DC12-24V power supply
V-		
A1	RS485(1)	Connect the pre-module
B1		
A2	RS485(2)	Connect the subsequent sub-module
B2		
KA1-KA15	A channel switch input	A passive switch input (15 channels)
COMA		
KB1-KB15	B channel switch input	B passive switch input (15 channels)
COMB		

AMC100-KD48

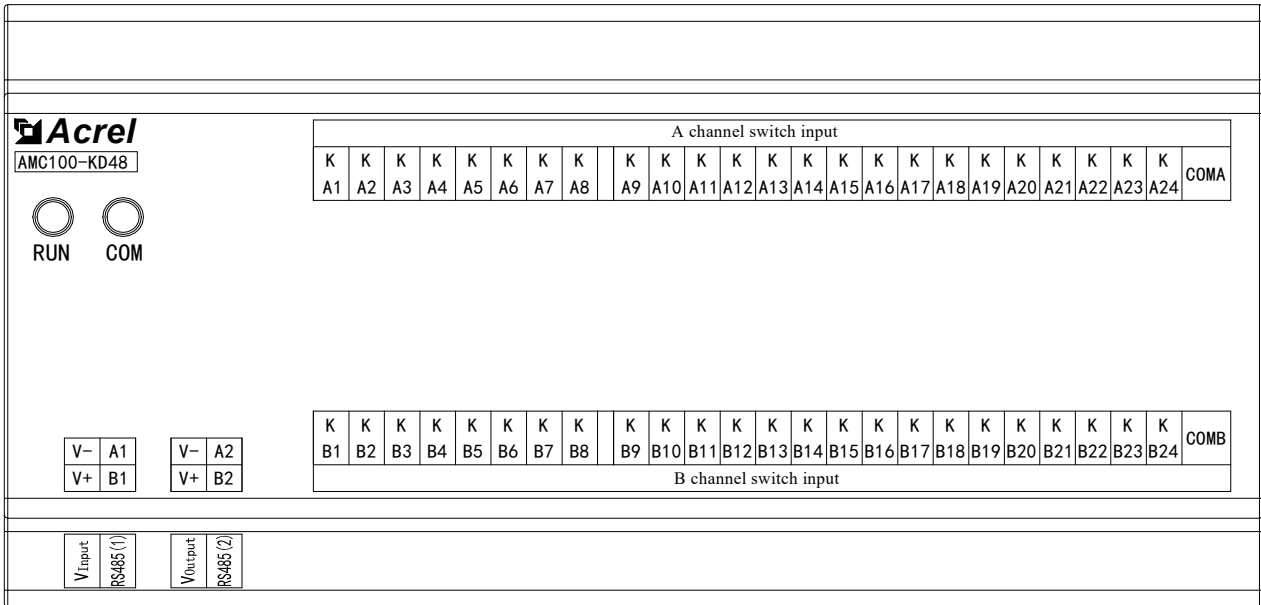

Definition	State	Remark
V+	Auxiliary supply	Powered by AMC100-ZD Or powered by DC12-24V power supply
V-		
A1	RS485(1)	Connect the pre-module
B1		
A2	RS485(2)	Connect the subsequent sub-module
B2		
KA1-KA24	A channel switch input	A passive switch input (24 channels)
COMA		
KB1-KB24	B channel switch input	B passive switch input (24 channels)
COMB		

5.6 AMC100-FT30/FT48 AMC100-FT30

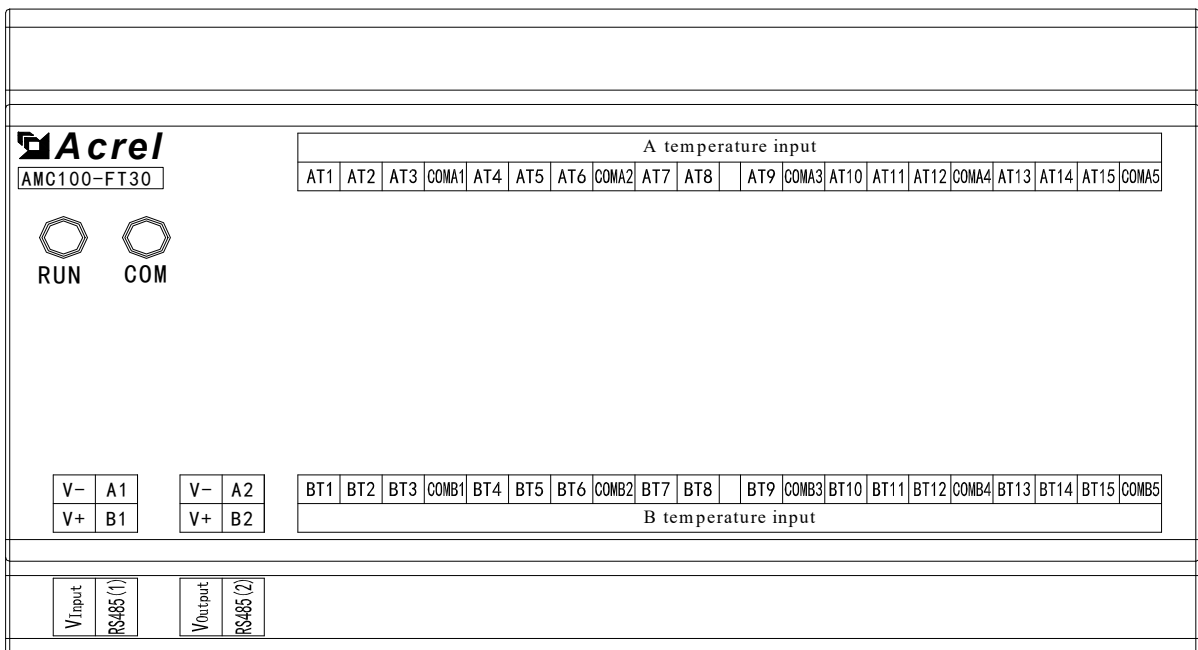

Definition	State	Remark
V+	Auxiliary power	Powered by AMC100-ZD Or powered by DC12-24V power supply
V-		
A1	RS485(1)	Connect the pre-module
B1		
A2	RS485(2)	Connect the subsequent sub-module
B2		
AT1-AT15	A channel temperature input	A temperature input(15 channels)
BT1-BT15	B channel temperature input	A temperature input(15 channels)

AMC100-FT48

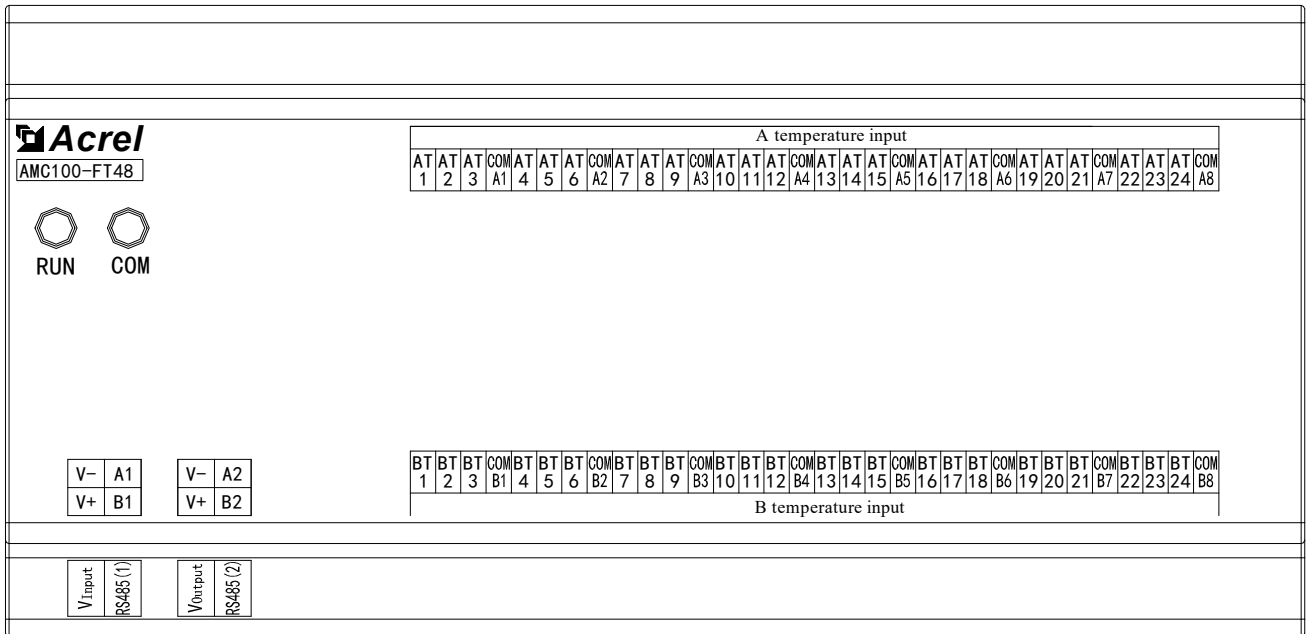

Definition	State	Remark
V+	Auxiliary supply	Powered by AMC100-ZD Or powered by DC12-24V power supply
V-		
A1	RS485(1)	Connect the pre-module
B1		
A2	RS485(2)	Connect the subsequent sub-module
B2		
AT1-AT24	A temperature input	A temperature input(24 channels)
BT1-BT24	B temperature input	A temperature input(24 channels)

6 Communication agreement

This protocol provides the physical connection and communication protocol of AMC100 series DC precision power distribution monitoring device and data terminal equipment for data exchange. The protocol mode is similar to Modbus_RTU communication protocol.

6.1 Sketch of the Protocol

The communication protocol used by AMC100 series DC devices defines in detail the data sequence definition of address code, function code and check code, which are the necessary content of specific data exchange. This protocol uses a master-slave response connection (half-duplex) on a single communication line, which means that signals are transmitted in two opposite directions on a single communication line. First, the host computer's signal is addressed to a unique terminal (slave), and then a reply from the terminal is transmitted in the opposite direction to the host.

This protocol only allows communication between the host (PC, PLC, etc.) and the terminal equipment, and does not allow data exchange between independent terminal equipment, so that the terminal equipment will not occupy the communication line during their initialization, but only to respond to the query signal reaching the local machine.

6.2 Transmission mode

Information is transmitted asynchronously and in bytes. The communication information transmitted between the host and the slave is in 11-bit word format, including 1 start bit, 8 data bits (the smallest significant bit is sent first), parity bit (no parity), and 1 stop bit.

Data frame format

Address code	Function code	Data area	CRC verification code
1 byte	1 byte	n byte	2 byte

6.2.1 Address field

The address field is at the beginning of the frame and consists of one byte (8-bit binary code) with decimal values ranging from 0 to 255. In our system, only 1 to 247 is used, and other addresses are reserved. These bits indicate the address of the user-specified terminal device that will receive data from the host connected to it. The address of each terminal device must be unique; only the terminal addressed will respond to queries containing that address. When the terminal sends back a response, the slave address data in the response tells the host which terminal is communicating with it.

6.2.2 Functional domain

The function domain code tells the terminal being addressed what function to perform. The following table lists the functional codes used in this series of devices and their meanings and functions.

Code	Meaning	Behavior
03	Read data register	Get the current binary value of one or more registers
16	Preset multiple registers	Set the binary value to a series of multiple registers

6.2.3 Data field

Data fields contain data required by the terminal to perform specific functions or collected by the terminal in response to queries. The contents of this data may be numeric values, reference addresses, or Settings. For example, the function field code tells the terminal to read a register, while the data field needs to indicate which register to start from and how much data to read. The embedded address and data vary according to the type and content of the slave.

6.2.4 Error checking field

This domain allows hosts and terminals to check for errors during transmission. Sometimes, due to electrical noise and other interference, a set of data may change on the line as it is transmitted from one device to another. Error checking ensures that the host or terminal does not respond to the data that has changed during transmission. This improves the security and efficiency of the system. Error checking uses the 16-bit cyclic redundancy method (CRC16).

6.2.5 Method of error detection

The error check field takes two bytes and contains a 16-bit binary value. The CRC value is calculated by the transmission device and then attached to the data frame. The receiving device recalculates the CRC value when it receives the data and then compares it with the value in the RECEIVED CRC domain. If the two values are not equal, an error occurs.

In CRC operation, a 16-bit register is first preset as all 1, and then 8 bits in each byte of the data frame are continuously evaluated with the current value of the register. Only 8 data bits in each byte participate in CRC generation, and CRC is not affected by the start and end bits as well as the possible parity bits. When CRC is generated, the 8 bits of each byte are XOR with the contents in the register, and then the result is shifted to the lower

level, the higher level is supplemented by "0", the lowest level (LSB) is moved out and detected, if it is 1, the register is xOR with a preset fixed value (0A001H), if the lowest level is 0, Do nothing.

The above process repeated, until the end of the eight times perform shift operation, when the last one (eighth) after, an 8-bit bytes and register under the current value of exclusive or operation, another eight times for the same shift xor operation, when all the bytes of a data frame processing, generate the final value is CRC value. The process for generating a CRC is:

(1) Presets a 16-bit register as FFFFH (all 1), called CRC register.

The 8 bits of the first byte in the data frame are XOR calculated with the low bytes in the CRC register, and the result is saved back to the CRC register. The CRC register is moved to the right one bit, the highest bit is filled with 0, and the lowest displacement is detected.

If the lowest order is 0, repeat the third step (next shift); If the lowest bit is 1: The CRC register is XOR with a preset fixed value (0A001H).

Repeat steps 3 and 4 until 8 shifts. This completes a full eight bits.

(2) Repeat steps 2 through 5 to process the next 8 bits until all bytes are processed. The final value of the CRC register is the value of CRC.

In addition, there is another method to calculate CRC using a preset table. Its main characteristic is fast calculation, but the table requires large storage space. This method will not be described here, please refer to the relevant information.

6.3 Function Code Introduction

6.3.1 Function code 03H: read register

This feature allows users to obtain data and system parameters collected and recorded by the device. There is no limit to the number of data requested by a host at a time, but the number cannot exceed the defined address range.

The following example is a collection of three basic data (2 bytes for each address in the data frame) from machine read 01: Uab, Ubc, and Uca, where the address of Uab is 03H, Ubc is 04H, and Uca is 05H.

Host send		Send Message
Address code		01H
Function s code		03H
Start address	High byte	00H
	Low byte	03H
Number of registers	High byte	00H
	Low byte	03H
CRC Check code	Low byte	F5H
	High byte	CBH

Return from the machine		Returned messages
Address code		01H
Function code		03H
Number of bytes		06H
Register data	High byte	0EH
	Low byte	EEH
Register data	High byte	0EH
	Low byte	E8H
Register data	Low byte	0EH
	High byte	E9H
CRC Check code	High byte	8FH
	Low byte	7EH

6.3.2 Function code 10H: write multiple registers

Function code 10H allows the user to change the contents of multiple registers, system parameters in the instrument, switching output state can be written by this function number. A host can write up to 16 (32 bytes) of data at a time.

The following example is a meter with a preset address of 01 that simultaneously outputs the switch DO. The address of the status indicator register for the output of the switch quantity is 0045H, and the first bit corresponds to DO.

Host send		Send Message
Address code		01H
Function s code		10H
Start address	High byte	00H
	Low byte	45H
Number of registers	High byte	00H
	Low byte	45H
Number of bytes		02H
0045H Data to be written	High byte	00H
	Low byte	01H
CRC Check code	Low byte	69H
	High byte	05H

Return from the machine		Returned messages
Address code		01H
Function code		10H
Start address	High byte	00H
	Low byte	45H
Number of registers	High byte	00H
	Low byte	01H
CRC Check code	Low byte	10H
	High byte	10H

6.4 Correspondence address

6.4.1 AMC100-ZD

Telemetry, remote control

Parameter area (0x0000 ~ 0x006A)

Number	Variate	Address	R/W	Length (bytes)	Unit	Date type
1	1 relay output	0x0000	R/W	2		u16
2	2 relay output	0x0001	R/W	2		u16
3	3 relay output	0x0002	R/W	2		u16
4	4 relay output	0x0003	R/W	2		u16
5	Power reset	0x0004	R/W	2		u16
6	Address1	0x0005	R/W	2	1-247	u16
7	Baud rate1	0x0006	R/W	2	Factory default 57600 0-115200 1-2400 2-4800 3-9600 4-19200 5-38400 6-57600 7-115200	u16
8	Check method1	0x0007	R/W	2	0-none 1-odd 2-even	u16
9	Address2	0x0008	R/W	2	1-247	u16
10	Baud rate2	0x0009	R/W	2	Factory default 57600 0-115200 1-2400 2-4800 3-9600 4-19200 5-38400 6-57600 7-115200	u16
11	Check method2	0x000A	R/W	2	0-none 1-odd 2-even	u16
12	Current zero	0x000B	R/W	2	0x8801 first road	u16
13	Rated voltage	0x000C	R/W	2	V	u16
14	Rated current1	0x000D	R/W	2	A	u16
15	Rated current2	0x000E	R/W	2	A	u16
16	Voltage transformation ratio	0x000F	R/W	2		u16
17	Incoming wire ratio1 ^①	0x0010	R/W	2		u16
18	Incoming wire ratio2	0x0011	R/W	2		u16
19	Outgoing mode (single and double)	0x0012	R/W	2	0-single 1-double	u16
20	Zero screen value	0x0013	R/W	2	0.1%	u16
21	Humidity alarm threshold	0x14-0x15	R/W	4	%	float
22	Humidity alarm threshold	0x16-0x17	R/W	4	°C	float
23	Slave address 1-20	0x18-0x2B	R/W	40	Set the address of the slave	u16

					connected later	
24	Spare	0x002C	R/W	2		u16
25	Spare	0x002D	R/W	2		u16
26	Spare	0x002E	R/W	2		u16
27	Spare	0x002F	R/W	2		u16
Incoming line alarm on side A	Spare	0x0030	R/W	4		float
	Spare	0x0032	R/W	4		float
	Spare	0x0034	R/W	4		float
	Spare	0x0036	R/W	4		float
	Spare	0x0038	R/W	4		float
	Spare	0x003A	R/W	4		float
	Spare	0x003C	R/W	4		float
	Power overload	0x003E	R/W	4	kW	float
	Current H2	0x0040	R/W	4	A	float
	Current H1	0x0042	R/W	4	A	float
	Current L1	0x0044	R/W	4	A	float
	Current L2	0x0046	R/W	4	A	float
	Over-voltage	0x0048	R/W	4	V	float
	Under-voltage	0x004A	R/W	4	V	float
Incoming line alarm on side B	Spare	0x004C	R/W	4		float
	Spare	0x004E	R/W	4		float
	Spare	0x0050	R/W	4		float
	Spare	0x0052	R/W	4		float
	Spare	0x0054	R/W	4		float
	Spare	0x0056	R/W	4		float
	Spare	0x0058	R/W	4		float
	Spare	0x005A	R/W	4		float
	Power overload	0x005C	R/W	4	kW	float
	Current H2	0x005E	R/W	4	A	float
	Current H1	0x0060	R/W	4	A	float
	Current L1	0x0062	R/W	4	A	float
	Current L2	0x0064	R/W	4	A	float
	Over-voltage	0x0066	R/W	4	V	float
Under-voltage	0x0068	R/W	4	V	float	
Spare	0x006A	R/W	4		float	

①Note: AMC100-ZD CT setting is different according to transformer model such as 100A/5V CT set to 100, 200A/5V set to 200.

Electrical parameter data area (0x0100 ~ 0x011E)

Number	Variate	Address	R/W	Length (bytes)	Unit	Date type
A	Voltage	0x0100	R	4	V	float
	Current	0x0102	R	4	A	float
	Active	0x0104	R	4	kW	float
	EP_imp	0x0106	R	4	kWh	u32
	EP_exp	0x0108	R	4	kWh	u32
	EP_T	0x010A	R	4	kWh	u32
	Load percentage	0x010C	R	4	%	float

B	Voltage	0x010E	R	4	V	float
	Current	0x0110	R	4	A	float
	Active	0x0112	R	4	kW	float
	EP_imp	0x0114	R	4	kWh	u32
	EP_exp	0x0116	R	4	kWh	u32
	EP_T	0x0118	R	4	kWh	u32
	Load percentage	0x011A	R	4	%	float
	Temperature	0x011C	R	4	%	float
	Humidity	0x011E	R	4	%	float

Alarm parameter reading

Variate	Address	R/W	Length (bytes)	Data type	Status bit								
					Bit15	Bit14	Bit13	Bit12	Bit11	Bit10	Bit9	Bit8	
Main module	0x01B0	R	2	u8	Humidity	Temperature			DO4	DO3	DO2	DO1	
					Bit7	Bit6	Bit5	Bit4	Bit3	Bit2	Bit1	Bit0	
					DI8	DI7	DI6	DI5	DI4	DI3	DI2	DI1	
					Bit15	Bit14	Bit13	Bit12	Bit11	Bit10	Bit9	Bit8	
A side incoming line alarm	0x01B1	R	2	u8									
					Bit7	Bit6	Bit5	Bit4	Bit3	Bit2	Bit1	Bit0	
						Power overload	Current H2	Current H1	Current L1	Current L2	Over-voltage	Under-voltage	
					Bit15	Bit14	Bit13	Bit12	Bit11	Bit10	Bit9	Bit8	
B side incoming line alarm	0x01B2	R	2	u16									
					Bit7	Bit6	Bit5	Bit4	Bit3	Bit2	Bit1	Bit0	
						Power overload	Current H2	Current H1	Current L1	Current L2	Over-voltage	Under-voltage	
					Bit15	Bit14	Bit13	Bit12	Bit11	Bit10	Bit9	Bit8	
Spare	0x01B3	R	2	u16									
Spare	0x01B4	R	2	u16									
Spare	0x01B5	R	2	u16									
Slave communication alarm	0x01B6	R	2	u16									
					Bit7	Bit6	Bit5	Bit4	Bit3	Bit2	Bit1	Bit0	
									Bit20	Bit19	Bit18	Bit17	
					Bit15	Bit14	Bit13	Bit12	Bit11	Bit10	Bit9	Bit8	
	0x01B7	R	2	u16									
					Bit15	Bit14	Bit13	Bit12	Bit11	Bit10	Bit9	Bit8	
					Bit16	Bit15	Bit14	Bit13	Bit12	Bit11	Bit10	Bit9	
					Bit7	Bit6	Bit5	Bit4	Bit3	Bit2	Bit1	Bit0	

6.4.2 AMC100-FDK48(30)/FD48(30)

Telemetry, remote control

Parameter area (0x0000 ~ 0x007F) **When the module is FDK30/FD30,CT and load values can be set as 1-15 and 25-39 channel parameters.**

Address	Variate	Remark	Length (bytes)	Unit	Date type
0x0000	Address	R/W	2	1-254, 0 is the universal address	u16
0x0001	Baud rate	R/W	2	0 115200 1-2400 2-4800 3-9600 4-19200 5-38400 6-57600 7-115200	u16
0x0002	Check method	R/W	2	0-None 1-odd 2-even	u16
0x0003	Spare	R/W	2		u16
0x0004	Power reset	R/W	2	0x6601--0x6630 Clear the power of the 1st--48th channel 0x66F1 Clear the 1-24 channel 0x66F2 Clear the 25--48 channel 0x66FF Clear the 1-48 channel	u16
0x0005	Mask value	R/W	2		u16
0x0006	Current zero	R/W	2	0x8801--0x8830 Clear the power of the 1st--48th channel 0x88F1 Clear the 1-24 channel 0x88F2 Clear the 25--48 channel 0x88FF Clear the 1-48 channel	u16
0x0007	Spare	R/W	2		u16
0x0008	Switch A	R/W	2	V	u16
0x0009	Over current ratio B2	R/W	2	%	u16
0x000A	Over current ratio B1	R/W	2	%	u16
0x000B	Low current ratio B1	R/W	2	%	u16
0x000C	Low current ratio B2	R/W	2	%	u16
0x000D	PT1	R/W	2	Voltage transformation ratio	u16
0x000E	CT1 ^①	R/W	2	Current transformation ratio of 1 circuit	u16
0x000F	CT2	R/W	2	Current transformation ratio of 2 circuit	u16
0x0010	CT3	R/W	2	Current transformation ratio of 3 circuit	u16
0x0011	CT4	R/W	2	Current transformation ratio of 4 circuit	u16
0x0012	CT5	R/W	2	Current transformation ratio of 5 circuit	u16
0x0013	CT6	R/W	2	Current transformation ratio of 6 circuit	u16
0x0014	CT7	R/W	2	Current transformation ratio of 7 circuit	u16
0x0015	CT8	R/W	2	Current transformation ratio of 8 circuit	u16
0x0016	CT9	R/W	2	Current transformation ratio of 9 circuit	u16
0x0017	CT10	R/W	2	Current transformation ratio of 10 circuit	u16
0x0018	CT11	R/W	2	Current transformation ratio of 11 circuit	u16
0x0019	CT12	R/W	2	Current transformation ratio of 12 circuit	u16
0x001A	CT13	R/W	2	Current transformation ratio of 13 circuit	u16
0x001B	CT14	R/W	2	Current transformation ratio of 14 circuit	u16
0x001C	CT15	R/W	2	Current transformation ratio of 15 circuit	u16
0x001D	CT16	R/W	2	Current transformation ratio of 16 circuit	u16
0x001E	CT17	R/W	2	Current transformation ratio of 17 circuit	u16
0x001F	CT18	R/W	2	Current transformation ratio of 18 circuit	u16
0x0020	CT19	R/W	2	Current transformation ratio of 19 circuit	u16
0x0021	CT20	R/W	2	Current transformation ratio of 20 circuit	u16
0x0022	CT21	R/W	2	Current transformation ratio of 21 circuit	u16

0x0023	CT22	R/W	2	Current transformation ratio of 22 circuit	u16
0x0024	CT23	R/W	2	Current transformation ratio of 23 circuit	u16
0x0025	CT24	R/W	2	Current transformation ratio of 24 circuit	u16
0x0026	ALLCT1	R/W	2	The default value is 1, when it is greater than 1, all CT values become ALLCT values, when it is 0, all CT values become 1, and ALLCT becomes 1 again after updating, without affecting other CT values	u16
0x0027	Rated load value of 1 circuit	R/W	2	If the Load parameter is set to 0, the alarm of this road will be turned off, and the load percentage of this road will be 0 the load percentage=current I /rated load value	u16
0x0028	Rated load value of 2 circuit	R/W	2	A	u16
0x0029	Rated load value of 3 circuit	R/W	2	A	u16
0x002A	Rated load value of 4 circuit	R/W	2	A	u16
0x002B	Rated load value of 5 circuit	R/W	2	A	u16
0x002C	Rated load value of 6 circuit	R/W	2	A	u16
0x002D	Rated load value of 7 circuit	R/W	2	A	u16
0x002E	Rated load value of 8 circuit	R/W	2	A	u16
0x002F	Rated load value of 9 circuit	R/W	2	A	u16
0x0030	Rated load value of 10 circuit	R/W	2	A	u16
0x0031	Rated load value of 11 circuit	R/W	2	A	u16
0x0032	Rated load value of 12 circuit	R/W	2	A	u16
0x0033	Rated load value of 13 circuit	R/W	2	A	u16
0x0034	Rated load value of 14 circuit	R/W	2	A	u16
0x0035	Rated load value of 15 circuit	R/W	2	A	u16
0x0036	Rated load value of 16 circuit	R/W	2	A	u16
0x0037	Rated load value of 17 circuit	R/W	2	A	u16
0x0038	Rated load value of 18 circuit	R/W	2	A	u16
0x0039	Rated load value of 19 circuit	R/W	2	A	u16
0x003A	Rated load value of 20 circuit	R/W	2	A	u16
0x003B	Rated load value of 21 circuit	R/W	2	A	u16
0x003C	Rated load value of 22 circuit	R/W	2	A	u16
0x003D	Rated load value of 23	R/W	2	A	u16

	circuit				
0x003E	Rated load value of 24 circuit	R/W	2		u16
0x003F	ALLLoadV1	R/W	2		u16
0x0040	Spare	R/W	2		u16
0x0041	Spare	R/W	2		u16
0x0042	Spare	R/W	2		u16
0x0043	Spare	R/W	2		u16
0x0044	Spare	R/W	2		u16
0x0045	Spare	R/W	2		u16
0x0046	Spare	R/W	2		u16
0x0047	Spare	R/W	2		u16
0x0048	Switch B	R/W	2	V	u16
0x0049	Over current ratio B2	R/W	2	%	u16
0x004A	Over current ratio B1	R/W	2	%	u16
0x004B	Low current ratio B1	R/W	2	%	u16
0x004C	Low current ratio B2	R/W	2	%	u16
0x004D	PT2	R/W	2	Voltage transformation ratio	u16
0x004E	CT25	R/W	2	Current transformation ratio of 25 circuit	u16
0x004F	CT26	R/W	2	Current transformation ratio of 26 circuit	u16
0x0050	CT27	R/W	2	Current transformation ratio of 27 circuit	u16
0x0051	CT28	R/W	2	Current transformation ratio of 28 circuit	u16
0x0052	CT29	R/W	2	Current transformation ratio of 29 circuit	u16
0x0053	CT30	R/W	2	Current transformation ratio of 30 circuit	u16
0x0054	CT31	R/W	2	Current transformation ratio of 31 circuit	u16
0x0055	CT32	R/W	2	Current transformation ratio of 32 circuit	u16
0x0056	CT33	R/W	2	Current transformation ratio of 33 circuit	u16
0x0057	CT34	R/W	2	Current transformation ratio of 34 circuit	u16
0x0058	CT35	R/W	2	Current transformation ratio of 35 circuit	u16
0x0059	CT36	R/W	2	Current transformation ratio of 36 circuit	u16
0x005A	CT37	R/W	2	Current transformation ratio of 37 circuit	u16
0x005B	CT38	R/W	2	Current transformation ratio of 38 circuit	u16
0x005C	CT39	R/W	2	Current transformation ratio of 39 circuit	u16
0x005D	CT40	R/W	2	Current transformation ratio of 40 circuit	u16
0x005E	CT41	R/W	2	Current transformation ratio of 41 circuit	u16
0x005F	CT42	R/W	2	Current transformation ratio of 42 circuit	u16
0x0060	CT43	R/W	2	Current transformation ratio of 43 circuit	u16
0x0061	CT44	R/W	2	Current transformation ratio of 44 circuit	u16
0x0062	CT45	R/W	2	Current transformation ratio of 45 circuit	u16
0x0063	CT46	R/W	2	Current transformation ratio of 46 circuit	u16
0x0064	CT47	R/W	2	Current transformation ratio of 47 circuit	u16

0x0065	CT48	R/W	2	Current transformation ratio of 48 circuit	u16
0x0066	ALLCT2	R/W	2	25-48 CT sets	u16
0x0067	Rated load value of 25 circuit	R/W	2	A	u16
0x0068	Rated load value of 26 circuit	R/W	2	A	u16
0x0069	Rated load value of 27 circuit	R/W	2	A	u16
0x006A	Rated load value of 28 circuit	R/W	2	A	u16
0x006B	Rated load value of 29 circuit	R/W	2	A	u16
0x006C	Rated load value of 30 circuit	R/W	2	A	u16
0x006D	Rated load value of 31 circuit	R/W	2	A	u16
0x006E	Rated load value of 32 circuit	R/W	2	A	u16
0x006F	Rated load value of 33 circuit	R/W	2	A	u16
0x0070	Rated load value of 34 circuit	R/W	2	A	u16
0x0071	Rated load value of 35 circuit	R/W	2	A	u16
0x0072	Rated load value of 36 circuit	R/W	2	A	u16
0x0073	Rated load value of 37 circuit	R/W	2	A	u16
0x0074	Rated load value of 38 circuit	R/W	2	A	u16
0x0075	Rated load value of 39 circuit	R/W	2	A	u16
0x0076	Rated load value of 40 circuit	R/W	2	A	u16
0x0077	Rated load value of 41 circuit	R/W	2	A	u16
0x0078	Rated load value of 42 circuit	R/W	2	A	u16
0x0079	Rated load value of 43 circuit	R/W	2	A	u16
0x007A	Rated load value of 44 circuit	R/W	2	A	u16
0x007B	Rated load value of 45 circuit	R/W	2	A	u16
0x007C	Rated load value of 46 circuit	R/W	2	A	u16
0x007D	Rated load value of 47 circuit	R/W	2	A	u16
0x007E	Rated load value of 48 circuit	R/W	2	A	u16
0x007F	ALLLoadV2	R/W	2	A	u16

①Note: AMC100-ZD CT setting is different according to transformer model such as 100A/5V CT set to 100, 200A/5V set to 200.

Electrical parameter data area (0x0090 ~ 0x03EF) When the module is FDK30/FD30,the valid data are 1-25 and 25-39 channels.When the module address is set to 20-29,the valid data is 1-30 channels.

Number	Number	Variate	Remark	Length (bytes)	Unit	Date type
1	0x0090	U(Voltage)	R	4	V	float
	0x0091					
	0x0092	I(Current)	R	4	A	
	0x0093					
	0x0094	P(active power)	R	4	kW	
	0x0095					
	0x0096					
	0x0097					
	0x0098					
	0x0099					
	0x009A					
	0x009B					
	0x009C	EP(active energy)	R	4	0.01kWh	u32
	0x009D					
	0x009E					
	0x009F					
0x00A0						
0x00A1	Load(Load percentage)	R load ratio=I/load value without decimal point	2	%	u16	
2	0x00A2	U(Voltage)	R	4	V	float
	0x00A3					
	0x00A4	I(Current)	R	4	A	
	0x00A5					
	0x00A6	P(active power)	R	4	kW	
	0x00A7					
	0x00A8					
	0x00A9					
	0x00AA					
	0x00AB					
	0x00AC					
	0x00AD					
	0x00AE	EP(active energy)	R	4	0.01kWh	u32
	0x00AF					
	0x00B0					
	0x00B1					
0x00B2						
0x00B3	Load(Load percentage)	R load ratio=I/load value without decimal point	2	%	u16	
3	0x00B4	U(Voltage)	R	4	V	float
	0x00B5					
	0x00B6	I(Current)	R	4	A	
	0x00B7					
	0x00B8	P(active power)	R	4	kW	
	0x00B9					
	0x00BA					
	0x00BB					
	0x00BC					
	0x00BD					
	0x00BE					
	0x00BF					

	0x00C0	EP(active energy)	R	4	0.01kWh	u32	
	0x00C1						
	0x00C2						
	0x00C3						
	0x00C4						
	0x00C5	Load(Load percentage)	R load ratio=I/load value without decimal point	2	%	u16	
4	0x00C6	U(Voltage)	R	4	V	float	
	0x00C7						
	0x00C8	I(Current)	R	4	A		
	0x00C9						
	0x00CA	P(active power)	R	4	kW		
	0x00CB						
	0x00CC						
	0x00CD						
	0x00CE						
	0x00CF						
	0x00D0						
	0x00D1						
	0x00D2	EP(active energy)	R	4	0.01kWh		u32
	0x00D3						
	0x00D4						
0x00D5							
0x00D6							
	0x00D7	Load(Load percentage)	R load ratio=I/load value without decimal point	2	%	u16	
5	0x00D8	U(Voltage)	R	4	V	float	
	0x00D9						
	0x00DA	I(Current)	R	4	A		
	0x00DB						
	0x00DC	P(active power)	R	4	kW		
	0x00DD						
	0x00DE						
	0x00DF						
	0x00E0						
	0x00E1						
	0x00E2						
	0x00E3						
	0x00E4	EP(active energy)	R	4	0.01kWh		u32
	0x00E5						
	0x00E6						
0x00E7							
0x00E8							
	0x00E9	Load(Load percentage)	R load ratio=I/load value without decimal point	2	%	u16	
6	0x00EA	U(Voltage)	R	4	V	float	
	0x00EB						
	0x00EC	I(Current)	R	4	A		
	0x00ED						
	0x00EE	P(active power)	R	4	kW		
0x00EF							

	0x00F0						
	0x00F1						
	0x00F2						
	0x00F3						
	0x00F4						
	0x00F5						
	0x00F6	EP(active energy)	R	4	0.01kWh	u32	
	0x00F7						
	0x00F8						
	0x00F9						
	0x00FA						
	0x00FB	Load(Load percentage)	R load ratio=I/load value without decimal point	2	%	u16	
7	0x00FC	U(Voltage)	R	4	V	float	
	0x00FD						
	0x00FE	I(Current)	R	4	A		
	0x00FF						
	0x0100	P(active power)	R	4	kW		
	0x0101						
	0x0102						
	0x0103						
	0x0104						
	0x0105						
	0x0106						
	0x0107						
	0x0108	EP(active energy)	R	4	0.01kWh		u32
	0x0109						
	0x010A						
	0x010B						
0x010C							
0x010D	Load(Load percentage)	R load ratio=I/load value without decimal point	2	%	u16		
8	0x010E	U(Voltage)	R	4	V	float	
	0x010F						
	0x0110	I(Current)	R	4	A		
	0x0111						
	0x0112	P(active power)	R	4	kW		
	0x0113						
	0x0114						
	0x0115						
	0x0116						
	0x0117						
	0x0118						
	0x0119						
	0x011A	EP(active energy)	R	4	0.01kWh		u32
	0x011B						
	0x011C						
	0x011D						
0x011E							
0x011F	Load(Load percentage)	R load ratio=I/load value without decimal point	2	%	u16		

9	0x0120	U(Voltage)	R	4	V	float	
	0x0121						
	0x0122	I(Current)	R	4	A		
	0x0123						
	0x0124	P(active power)	R	4	kW		
	0x0125						
	0x0126						
	0x0127						
	0x0128						
	0x0129						
	0x012A						
	0x012B						
	0x012C	EP(active energy)	R	4	0.01kWh		u32
	0x012D						
	0x012E						
	0x012F						
	0x0130						
0x0131	Load(Load percentage)	R load ratio=I/load value without decimal point	2	%	u16		
10	0x0132	U(Voltage)	R	4	V	float	
	0x0133						
	0x0134	I(Current)	R	4	A		
	0x0135						
	0x0136	P(active power)	R	4	kW		
	0x0137						
	0x0138						
	0x0139						
	0x013A						
	0x013B						
	0x013C						
	0x013D						
	0x013E	EP(active energy)	R	4	0.01kWh		u32
	0x013F						
	0x0140						
	0x0141						
	0x0142						
0x0143	Load(Load percentage)	R load ratio=I/load value without decimal point	2	%	u16		
11	0x0144	U(Voltage)	R	4	V	float	
	0x0145						
	0x0146	I(Current)	R	4	A		
	0x0147						
	0x0148	P(active power)	R	4	kW		
	0x0149						
	0x014A						
	0x014B						
	0x014C						
	0x014D						
	0x014E						
	0x014F						

	0x0150	EP(active energy)	R	4	0.01kWh	u32	
	0x0151						
	0x0152						
	0x0153						
	0x0154						
	0x0155	Load(Load percentage)	R load ratio=I/load value without decimal point	2	%	u16	
12	0x0156	U(Voltage)	R	4	V	float	
	0x0157						
	0x0158	I(Current)	R	4	A		
	0x0159						
	0x015A	P(active power)	R	4	kW		
	0x015B						
	0x015C						
	0x015D						
	0x015E						
	0x015F						
	0x0160						
	0x0161						
	0x0162	EP(active energy)	R	4	0.01kWh		u32
	0x0163						
	0x0164						
0x0165							
0x0166							
	0x0167	Load(Load percentage)	R load ratio=I/load value without decimal point	2	%	u16	
13	0x0168	U(Voltage)	R	4	V	float	
	0x0169						
	0x016A	I(Current)	R	4	A		
	0x016B						
	0x016C	P(active power)	R	4	kW		
	0x016D						
	0x016E						
	0x016F						
	0x0170						
	0x0171						
	0x0172						
	0x0173						
	0x0174	EP(active energy)	R	4	0.01kWh		u32
	0x0175						
	0x0176						
0x0177							
0x0178							
	0x0179	Load(Load percentage)	R load ratio=I/load value without decimal point	2	%	u16	
14	0x017A	U(Voltage)	R	4	V	float	
	0x017B						
	0x017C	I(Current)	R	4	A		
	0x017D						
	0x017E	P(active power)	R	4	kW		
0x017F							

	0x0180						
	0x0181						
	0x0182						
	0x0183						
	0x0184						
	0x0185						
	0x0186	EP(active energy)	R	4	0.01kWh	u32	
	0x0187						
	0x0188						
	0x0189						
	0x018A						
	0x018B	Load(Load percentage)	R load ratio=I/load value without decimal point	2	%	u16	
15	0x018C	U(Voltage)	R	4	V	float	
	0x018D						
	0x018E	I(Current)	R	4	A		
	0x018F						
	0x0190	P(active power)	R	4	kW		
	0x0191						
	0x0192						
	0x0193						
	0x0194						
	0x0195						
	0x0196						
	0x0197						
	0x0198	EP(active energy)	R	4	0.01kWh		u32
	0x0199						
	0x019A						
	0x019B						
0x019C							
0x019D	Load(Load percentage)	R load ratio=I/load value without decimal point	2	%	u16		
16	0x019E	U(Voltage)	R	4	V	float	
	0x019F						
	0x01A0	I(Current)	R	4	A		
	0x01A1						
	0x01A2	P(active power)	R	4	kW		
	0x01A3						
	0x01A4						
	0x01A5						
	0x01A6						
	0x01A7						
	0x01A8						
	0x01A9						
	0x01AA	EP(active energy)	R	4	0.01kWh		u32
	0x01AB						
	0x01AC						
	0x01AD						
0x01AE							
0x01AF	Load(Load percentage)	R load ratio=I/load value without decimal point	2	%	u16		

17	0x01B0	U(Voltage)	R	4	V	float	
	0x01B1						
	0x01B2	I(Current)	R	4	A		
	0x01B3						
	0x01B4	P(active power)	R	4	kW		
	0x01B5						
	0x01B6						
	0x01B7						
	0x01B8						
	0x01B9						
	0x01BA						
	0x01BB						
	0x01BC	EP(active energy)	R	4	0.01kWh		u32
	0x01BD						
	0x01BE						
	0x01BF						
	0x01C0						
0x01C1	Load(Load percentage)	R load ratio=I/load value without decimal point	2	%	u16		
18	0x01C2	U(Voltage)	R	4	V	float	
	0x01C3						
	0x01C4	I(Current)	R	4	A		
	0x01C5						
	0x01C6	P(active power)	R	4	kW		
	0x01C7						
	0x01C8						
	0x01C9						
	0x01CA						
	0x01CB						
	0x01CC						
	0x01CD						
	0x01CE	EP(active energy)	R	4	0.01kWh		u32
	0x01CF						
	0x01D0						
	0x01D1						
	0x01D2						
0x01D3	Load(Load percentage)	R load ratio=I/load value without decimal point	2	%	u16		
19	0x01D4	U(Voltage)	R	4	V	float	
	0x01D5						
	0x01D6	I(Current)	R	4	A		
	0x01D7						
	0x01D8	P(active power)	R	4	kW		
	0x01D9						
	0x01DA						
	0x01DB						
	0x01DC						
	0x01DD						
	0x01DE						
0x01DF							

	0x01E0	EP(active energy)	R	4	0.01kWh	u32	
	0x01E1						
	0x01E2						
	0x01E3						
	0x01E4						
	0x01E5	Load(Load percentage)	R load ratio=I/load value without decimal point	2	%	u16	
20	0x01E6	U(Voltage)	R	4	V	float	
	0x01E7						
	0x01E8	I(Current)	R	4	A		
	0x01E9						
	0x01EA	P(active power)	R	4	kW		
	0x01EB						
	0x01EC						
	0x01ED						
	0x01EE						
	0x01EF						
	0x01F0						
	0x01F1						
	0x01F2	EP(active energy)	R	4	0.01kWh		u32
	0x01F3						
	0x01F4						
0x01F5							
0x01F6							
	0x01F7	Load(Load percentage)	R load ratio=I/load value without decimal point	2	%	u16	
21	0x01F8	U(Voltage)	R	4	V	float	
	0x01F9						
	0x01FA	I(Current)	R	4	A		
	0x01FB						
	0x01FC	P(active power)	R	4	kW		
	0x01FD						
	0x01FE						
	0x01FF						
	0x0200						
	0x0201						
	0x0202						
	0x0203						
	0x0204	EP(active energy)	R	4	0.01kWh		u32
	0x0205						
	0x0206						
0x0207							
0x0208							
	0x0209	Load(Load percentage)	R load ratio=I/load value without decimal point	2	%	u16	
22	0x020A	U(Voltage)	R	4	V	float	
	0x020B						
	0x020C	I(Current)	R	4	A		
	0x020D						
	0x020E	P(active power)	R	4	kW		
	0x020F						

	0x0210						
	0x0211						
	0x0212						
	0x0213						
	0x0214						
	0x0215						
	0x0216	EP(active energy)	R	4	0.01kWh	u32	
	0x0217						
	0x0218						
	0x0219						
	0x021A						
	0x021B	Load(Load percentage)	R load ratio=I/load value without decimal point	2	%	u16	
23	0x021C	U(Voltage)	R	4	V	float	
	0x021D						
	0x021E	I(Current)	R	4	A		
	0x021F						
	0x0220	P(active power)	R	4	kW		
	0x0221						
	0x0222						
	0x0223						
	0x0224						
	0x0225						
	0x0226						
	0x0227						
	0x0228	EP(active energy)	R	4	0.01kWh		u32
	0x0229						
	0x022A						
	0x022B						
0x022C							
0x022D	Load(Load percentage)	R load ratio=I/load value without decimal point	2	%	u16		
24	0x022E	U(Voltage)	R	4	V	float	
	0x022F						
	0x0230	I(Current)	R	4	A		
	0x0231						
	0x0232	P(active power)	R	4	kW		
	0x0233						
	0x0234						
	0x0235						
	0x0236						
	0x0237						
	0x0238						
	0x0239						
	0x023A	EP(active energy)	R	4	0.01kWh		u32
	0x023B						
	0x023C						
	0x023D						
0x023E							
0x023F	Load(Load percentage)	R load ratio=I/load value without decimal point	2	%	u16		

25	0x0240	U(Voltage)	R	4	V	float	
	0x0241						
	0x0242	I(Current)	R	4	A		
	0x0243						
	0x0244	P(active power)	R	4	kW		
	0x0245						
	0x0246						
	0x0247						
	0x0248						
	0x0249						
	0x024A						
	0x024B						
	0x024C	EP(active energy)	R	4	0.01kWh		u32
	0x024D						
	0x024E						
	0x024F						
	0x0250						
0x0251	Load(Load percentage)	R load ratio=I/load value without decimal point	2	%	u16		
26	0x0252	U(Voltage)	R	4	V	float	
	0x0253						
	0x0254	I(Current)	R	4	A		
	0x0255						
	0x0256	P(active power)	R	4	kW		
	0x0257						
	0x0258						
	0x0259						
	0x025A						
	0x025B						
	0x025C						
	0x025D						
	0x025E	EP(active energy)	R	4	0.01kWh		u32
	0x025F						
	0x0260						
	0x0261						
	0x0262						
0x0263	Load(Load percentage)	R load ratio=I/load value without decimal point	2	%	u16		
27	0x0264	U(Voltage)	R	4	V	float	
	0x0265						
	0x0266	I(Current)	R	4	A		
	0x0267						
	0x0268	P(active power)	R	4	kW		
	0x0269						
	0x026A						
	0x026B						
	0x026C						
	0x026D						
	0x026E						
	0x026F						

	0x0270	EP(active energy)	R	4	0.01kWh	u32	
	0x0271						
	0x0272						
	0x0273						
	0x0274						
	0x0275	Load(Load percentage)	R load ratio=I/load value without decimal point	2	%	u16	
28	0x0276	U(Voltage)	R	4	V	float	
	0x0277						
	0x0278	I(Current)	R	4	A		
	0x0279						
	0x027A	P(active power)	R	4	kW		
	0x027B						
	0x027C						
	0x027D						
	0x027E						
	0x027F						
	0x0280						
	0x0281						
	0x0282	EP(active energy)	R	4	0.01kWh		u32
	0x0283						
	0x0284						
	0x0285						
0x0286							
0x0287	Load(Load percentage)	R load ratio=I/load value without decimal point	2	%	u16		
29	0x0288	U(Voltage)	R	4	V	float	
	0x0289						
	0x028A	I(Current)	R	4	A		
	0x028B						
	0x028C	P(active power)	R	4	kW		
	0x028D						
	0x028E						
	0x028F						
	0x0290						
	0x0291						
	0x0292						
	0x0293						
	0x0294	EP(active energy)	R	4	0.01kWh		u32
	0x0295						
	0x0296						
	0x0297						
0x0298							
0x0299	Load(Load percentage)	R load ratio=I/load value without decimal point	2	%	u16		
30	0x029A	U(Voltage)	R	4	V	float	
	0x029B						
	0x029C	I(Current)	R	4	A		
	0x029D						
	0x029E	P(active power)	R	4	kW		
	0x029F						

	0x02A0						
	0x02A1						
	0x02A2						
	0x02A3						
	0x02A4						
	0x02A5						
	0x02A6	EP(active energy)	R	4	0.01kWh	u32	
	0x02A7						
	0x02A8						
	0x02A9						
	0x02AA						
	0x02AB	Load(Load percentage)	R load ratio=I/load value without decimal point	2	%	u16	
31	0x02AC	U(Voltage)	R	4	V	float	
	0x02AD						
	0x02AE	I(Current)	R	4	A		
	0x02AF						
	0x02B0	P(active power)	R	4	kW		
	0x02B1						
	0x02B2						
	0x02B3						
	0x02B4						
	0x02B5						
	0x02B6						
	0x02B7						
	0x02B8	EP(active energy)	R	4	0.01kWh		u32
	0x02B9						
	0x02BA						
0x02BB							
0x02BC							
0x02BD	Load(Load percentage)	R load ratio=I/load value without decimal point	2	%	u16		
32	0x02BE	U(Voltage)	R	4	V	float	
	0x02BF						
	0x02C0	I(Current)	R	4	A		
	0x02C1						
	0x02C2	P(active power)	R	4	kW		
	0x02C3						
	0x02C4						
	0x02C5						
	0x02C6						
	0x02C7						
	0x02C8						
	0x02C9						
	0x02CA	EP(active energy)	R	4	0.01kWh		u32
	0x02CB						
	0x02CC						
0x02CD							
0x02CE							
0x02CF	Load(Load percentage)	R load ratio=I/load value without decimal point	2	%	u16		

33	0x02D0	U(Voltage)	R	4	V	float	
	0x02D1						
	0x02D2	I(Current)	R	4	A		
	0x02D3						
	0x02D4	P(active power)	R	4	kW		
	0x02D5						
	0x02D6						
	0x02D7						
	0x02D8						
	0x02D9						
	0x02DA						
	0x02DB						
	0x02DC	EP(active energy)	R	4	0.01kWh		u32
	0x02DD						
	0x02DE						
	0x02DF						
0x02E0							
0x02E1	Load(Load percentage)	R load ratio=I/load value without decimal point	2	%	u16		
34	0x02E2	U(Voltage)	R	4	V	float	
	0x02E3						
	0x02E4	I(Current)	R	4	A		
	0x02E5						
	0x02E6	P(active power)	R	4	kW		
	0x02E7						
	0x02E8						
	0x02E9						
	0x02EA						
	0x02EB						
	0x02EC						
	0x02ED						
	0x02EE	EP(active energy)	R	4	0.01kWh		u32
	0x02EF						
	0x02F0						
	0x02F1						
0x02F2							
0x02F3	Load(Load percentage)	R load ratio=I/load value without decimal point	2	%	u16		
35	0x02F4	U(Voltage)	R	4	V	float	
	0x02F5						
	0x02F6	I(Current)	R	4	A		
	0x02F7						
	0x02F8	P(active power)	R	4	kW		
	0x02F9						
	0x02FA						
	0x02FB						
	0x02FC						
	0x02FD						
	0x02FE						
0x02FF							

	0x0300	EP(active energy)	R	4	0.01kWh	u32	
	0x0301						
	0x0302						
	0x0303						
	0x0304						
	0x0305	Load(Load percentage)	R load ratio=I/load value without decimal point	2	%	u16	
36	0x0306	U(Voltage)	R	4	V	float	
	0x0307						
	0x0308	I(Current)	R	4	A		
	0x0309						
	0x030A	P(active power)	R	4	kW		
	0x030B						
	0x030C						
	0x030D						
	0x030E						
	0x030F						
	0x0310						
	0x0311						
	0x0312	EP(active energy)	R	4	0.01kWh		u32
	0x0313						
	0x0314						
	0x0315						
0x0316							
	0x0317	Load(Load percentage)	R load ratio=I/load value without decimal point	2	%	u16	
37	0x0318	U(Voltage)	R	4	V	float	
	0x0319						
	0x031A	I(Current)	R	4	A		
	0x031B						
	0x031C	P(active power)	R	4	kW		
	0x031D						
	0x031E						
	0x031F						
	0x0320						
	0x0321						
	0x0322						
	0x0323						
	0x0324	EP(active energy)	R	4	0.01kWh		u32
	0x0325						
	0x0326						
	0x0327						
0x0328							
	0x0329	Load(Load percentage)	R load ratio=I/load value without decimal point	2	%	u16	
38	0x032A	U(Voltage)	R	4	V	float	
	0x032B						
	0x032C	I(Current)	R	4	A		
	0x032D						
	0x032E	P(active power)	R	4	kW		
	0x032F						

	0x0330						
	0x0331						
	0x0332						
	0x0333						
	0x0334						
	0x0335						
	0x0336	EP(active energy)	R	4	0.01kWh	u32	
	0x0337						
	0x0338						
	0x0339						
	0x033A						
	0x033B	Load(Load percentage)	R load ratio=I/load value without decimal point	2	%	u16	
39	0x033C	U(Voltage)	R	4	V	float	
	0x033D						
	0x033E	I(Current)	R	4	A		
	0x033F						
	0x0340	P(active power)	R	4	kW		
	0x0341						
	0x0342						
	0x0343						
	0x0344						
	0x0345						
	0x0346						
	0x0347						
	0x0348	EP(active energy)	R	4	0.01kWh		u32
	0x0349						
	0x034A						
	0x034B						
0x034C							
0x034D	Load(Load percentage)	R load ratio=I/load value without decimal point	2	%	u16		
40	0x034E	U(Voltage)	R	4	V	float	
	0x034F						
	0x0350	I(Current)	R	4	A		
	0x0351						
	0x0352	P(active power)	R	4	kW		
	0x0353						
	0x0354						
	0x0355						
	0x0356						
	0x0357						
	0x0358						
	0x0359						
	0x035A	EP(active energy)	R	4	0.01kWh		u32
	0x035B						
	0x035C						
	0x035D						
0x035E							
0x035F	Load(Load percentage)	R load ratio=I/load value without decimal point	2	%	u16		

41	0x0360	U(Voltage)	R	4	V	float	
	0x0361						
	0x0362	I(Current)	R	4	A		
	0x0363						
	0x0364	P(active power)	R	4	kW		
	0x0365						
	0x0366						
	0x0367						
	0x0368						
	0x0369						
	0x036A						
	0x036B						
	0x036C	EP(active energy)	R	4	0.01kWh		u32
	0x036D						
	0x036E						
	0x036F						
0x0370							
0x0371	Load(Load percentage)	R load ratio=I/load value without decimal point	2	%	u16		
42	0x0372	U(Voltage)	R	4	V	float	
	0x0373						
	0x0374	I(Current)	R	4	A		
	0x0375						
	0x0376	P(active power)	R	4	kW		
	0x0377						
	0x0378						
	0x0379						
	0x037A						
	0x037B						
	0x037C						
	0x037D						
	0x037E	EP(active energy)	R	4	0.01kWh		u32
	0x037F						
	0x0380						
	0x0381						
0x0382							
0x0383	Load(Load percentage)	R load ratio=I/load value without decimal point	2	%	u16		
43	0x0384	U(Voltage)	R	4	V	float	
	0x0385						
	0x0386	I(Current)	R	4	A		
	0x0387						
	0x0388	P(active power)	R	4	kW		
	0x0389						
	0x038A						
	0x038B						
	0x038C						
	0x038D						
	0x038E						
0x038F							

	0x0390	EP(active energy)	R	4	0.01kWh	u32
	0x0391					
	0x0392					
	0x0393					
	0x0394					
	0x0395	Load(Load percentage)	R load ratio=I/load value without decimal point	2	%	u16
44	0x0396	U(Voltage)	R	4	V	float
	0x0397					
	0x0398	I(Current)	R	4	A	
	0x0399					
	0x039A	P(active power)	R	4	kW	
	0x039B					
	0x039C					
	0x039D					
	0x039E					
	0x039F					
	0x03A0					
	0x03A1					
	0x03A2	EP(active energy)	R	4	0.01kWh	
	0x03A3					
	0x03A4					
	0x03A5					
	0x03A6					
	0x03A7	Load(Load percentage)	R load ratio=I/load value without decimal point	2	%	u16
45	0x03A8	U(Voltage)	R	4	V	float
	0x03A9					
	0x03AA	I(Current)	R	4	A	
	0x03AB					
	0x03AC	P(active power)	R	4	kW	
	0x03AD					
	0x03AE					
	0x03AF					
	0x03B0					
	0x03B1					
	0x03B2					
	0x03B3					
	0x03B4	EP(active energy)	R	4	0.01kWh	
	0x03B5					
	0x03B6					
0x03B7						
0x03B8						
	0x03B9	Load(Load percentage)	R load ratio=I/load value without decimal point	2	%	u16
46	0x03BA	U(Voltage)	R	4	V	float
	0x03BB					
	0x03BC	I(Current)	R	4	A	
	0x03BD					
	0x03BE	P(active power)	R	4	kW	
	0x03BF					

	0x03C0						
	0x03C1						
	0x03C2						
	0x03C3						
	0x03C4						
	0x03C5						
	0x03C6	EP(active energy)	R	4	0.01kWh	u32	
	0x03C7						
	0x03C8						
	0x03C9						
	0x03CA						
	0x03CB	Load(Load percentage)	R load ratio=I/load value without decimal point	2	%	u16	
47	0x03CC	U(Voltage)	R	4	V	float	
	0x03CD						
	0x03CE	I(Current)	R	4	A		
	0x03CF						
	0x03D0	P(active power)	R	4	kW		
	0x03D1						
	0x03D2						
	0x03D3						
	0x03D4						
	0x03D5						
	0x03D6						
	0x03D7						
	0x03D8	EP(active energy)	R	4	0.01kWh		u32
	0x03D9						
	0x03DA						
	0x03DB						
0x03DC							
0x03DD	Load(Load percentage)	R load ratio=I/load value without decimal point	2	%	u16		
48	0x03DE	U(Voltage)	R	4	V	float	
	0x03DF						
	0x03E0	I(Current)	R	4	A		
	0x03E1						
	0x03E2	P(active power)	R	4	kW		
	0x03E3						
	0x03E4						
	0x03E5						
	0x03E6						
	0x03E7						
	0x03E8						
	0x03E9						
	0x03EA	EP(active energy)	R	4	0.01kWh		u32
	0x03EB						
	0x03EC						
	0x03ED						
0x03EE							
0x03EF	Load(Load percentage)	R load ratio=I/load value without decimal point	2	%	u16		

The alarm status data (0x03F0~0x0420) When the module is FDK30/FD30,the effective alarm data are 1-15 and 25-39 channels of data,When the address is set to 20-29, the effective alarm data is 1-30 channels.When the module is FD48(30),the status bit of switching value is always 0 and no acquisition is required.

Alarm status assignment

Bit15	Bit14	Bit13	Bit12	Bit11	Bit10	Bit9	Bit8
Bit7	Bit6	Bit5	Bit4	Bit3	Bit2	Bit1	Bit0
			Switching value	Over current level II alarm	Over current level I alarm	Under current level I alarm	Under current level II alarm

Number	Address	Variate	Remark	Length (bytes)	Type
1	0x03F0	ALMData1 (channel 1 alarm status)	R	2	u16
2	0x03F1	ALMData2 (channel 2 alarm status)	R	2	u16
3	0x03F2	ALMData3 (channel 3 alarm status)	R	2	u16
4	0x03F3	ALMData4 (channel 4 alarm status)	R	2	u16
5	0x03F4	ALMData5 (channel 5 alarm status)	R	2	u16
6	0x03F5	ALMData6 (channel 6 alarm status)	R	2	u16
7	0x03F6	ALMData7 (channel 7 alarm status)	R	2	u16
8	0x03F7	ALMData8 (channel 8 alarm status)	R	2	u16
9	0x03F8	ALMData9 (channel 9 alarm status)	R	2	u16
10	0x03F9	ALMData10 (channel 10 alarm status)	R	2	u16
11	0x03FA	ALMData11 (channel 11 alarm status)	R	2	u16
12	0x03FB	ALMData12 (channel 12 alarm status)	R	2	u16
13	0x03FC	ALMData13 (channel 13 alarm status)	R	2	u16
14	0x03FD	ALMData14 (channel 14 alarm status)	R	2	u16
15	0x03FE	ALMData15 (channel 15 alarm status)	R	2	u16
16	0x03FF	ALMData16 (channel 16 alarm status)	R	2	u16
17	0x0400	ALMData17 (channel 17 alarm status)	R	2	u16
18	0x0401	ALMData18 (channel 18 alarm status)	R	2	u16
19	0x0402	ALMData19 (channel 19 alarm status)	R	2	u16
20	0x0403	ALMData20 (channel 20 alarm status)	R	2	u16
21	0x0404	ALMData21 (channel 21 alarm status)	R	2	u16
22	0x0405	ALMData22 (channel 22 alarm status)	R	2	u16
23	0x0406	ALMData23 (channel 23 alarm status)	R	2	u16
24	0x0407	ALMData24 (channel 24 alarm status)	R	2	u16
25	0x0408	ALMData25 (channel 25 alarm status)	R	2	u16
26	0x0409	ALMData26 (channel 26 alarm status)	R	2	u16
27	0x040A	ALMData27 (channel 27 alarm status)	R	2	u16
28	0x040B	ALMData28 (channel 28 alarm status)	R	2	u16
29	0x040C	ALMData29 (channel 29 alarm status)	R	2	u16
30	0x040D	ALMData30 (channel 30 alarm status)	R	2	u16
31	0x040E	ALMData31 (channel 31 alarm status)	R	2	u16
32	0x040F	ALMData32 (channel 32 alarm status)	R	2	u16

33	0x0410	ALMData33 (channel 33 alarm status)	R	2	u16
34	0x0411	ALMData34 (channel 34 alarm status)	R	2	u16
35	0x0412	ALMData35 (channel 35 alarm status)	R	2	u16
36	0x0413	ALMData36 (channel 36 alarm status)	R	2	u16
37	0x0414	ALMData37 (channel 37 alarm status)	R	2	u16
38	0x0415	ALMData38 (channel 38 alarm status)	R	2	u16
39	0x0416	ALMData39 (channel 39 alarm status)	R	2	u16
40	0x0417	ALMData40 (channel 40 alarm status)	R	2	u16
41	0x0418	ALMData41 (channel 41 alarm status)	R	2	u16
42	0x0419	ALMData42 (channel 42 alarm status)	R	2	u16
43	0x041A	ALMData43 (channel 43 alarm status)	R	2	u16
44	0x041B	ALMData44 (channel 44 alarm status)	R	2	u16
45	0x041C	ALMData45 (channel 45 alarm status)	R	2	u16
46	0x041D	ALMData46 (channel 46 alarm status)	R	2	u16
47	0x041E	ALMData47 (channel 47 alarm status)	R	2	u16
48	0x041F	ALMData48 (channel 48 alarm status)	R	2	u16
	0x0420				

7 Matters need attention

- 7.1 The device should be installed in a dry, clean place away from heat source and strong electromagnetic field.
- 7.2 Attention should be paid to the phase sequence and polarity of AC voltage and current when the device is connected, otherwise the measurement will be inaccurate.
- 7.3 The current input must use CT, and the variable ratio parameters of incoming CT must be set through communication.
- 7.4 The accuracy of CT affects the measurement accuracy of this device. The angular difference of CT will affect the measuring accuracy of power and electric energy.
- 7.5 2A fuse should be installed for direct access systems without PT.
- 7.6 The CT grounding terminal of the current input on the device should be led to the grounding terminal separately. It is not allowed to connect the current input grounding terminal in parallel and then lead to the grounding terminal on the device.
- 7.7 Communication cable should use shielded twisted pair.

8 Common fault diagnosis and troubleshooting methods

- 8.1 The measurement of the device is not accurate
- *Check whether the wiring of voltage and current is correct, and whether the incoming and outgoing lines of current input are correct;
 - *Check whether the CT setting of the device corresponds to the actual CT used externally;
- 8.2 The voltage and current are measured correctly, but the power is not measured accurately.
- *Check whether the current input direction is correct;
 - *Check whether the corresponding phase of each current loop is correct; The outgoing circuit shall be adjusted according to actual access.
- 8.3 Abnormal communication
- *Check whether the communication cable is connected normally;
 - *Check whether the A and B terminals of communication are interlaced;
 - *Check whether the address of the device is set correctly and the communication baud rate is set correctly;
 - *When the communication of multiple devices is abnormal, first try whether the single communication is normal;
- 8.4 There is incoming voltage, current, and power, but electricity has no value.
- *Check the CT ratio setting of the incoming line.

Change record:

Before change	After change	Change content
V1.0	V1.1	1、 Fixed some errors in the text; 2、 Delete the measurement accuracy in FT30/48 technical parameters;

Headquarters: Acrel Co., LTD.

Address: No.253 Yulv Road Jiading District, Shanghai , China

TEL.: 0086-21-69158338 0086-21-69156052 0086-21-59156392 0086-21-69156971

Fax: 0086-21-69158303

Web-site: www.acrel-electric.com

E-mail: ACREL008@vip.163.com

Postcode: 201801

Manufacturer: Jiangsu Acrel Electrical Manufacturing Co., LTD.

Address: No.5 Dongmeng Road,Dongmeng industrial Park, Nanzha Street, Jiangyin City, Jiangsu Province, China

TEL : 0086-510-86179966

Fax : 0086-510-86179975

Web-site: www.jsacrel.com

Postcode: 214405

E-mail: sales@email.acrel.cn